

**LOREA skrinka s dvojumývadlom 161x46x51,5cm
(70+20+70cm), dub alabama/biela matná**



Objednací kód: LE070-2231-09

Základné informácie

Značka: Sapho
Séria: LOREA

Rozmery

Šírka: 1610 mm
Výška: 460 mm
Hĺbka: 515 mm

Vlastnosti

Farba: Hnedá
Dekor: Dub Alabama
Možnosti farebného prevedenia: Podľa vzorkovníka
Materiál: MDF/lamino
Inštalácia: Závesné na stenu
Typ skrinky: Zásuvky
Typ umývadla: Dvojumývadlo
Výbava: Automatické dovretie
Hmotnosť / ks: 88.347 kg
Balenie: 4 ks
Záruka: 2 roky



LOREA skrinka s dvojumývadlom 161x46x51,5cm
(70+20+70cm), dub alabama/biela matná



Technický list

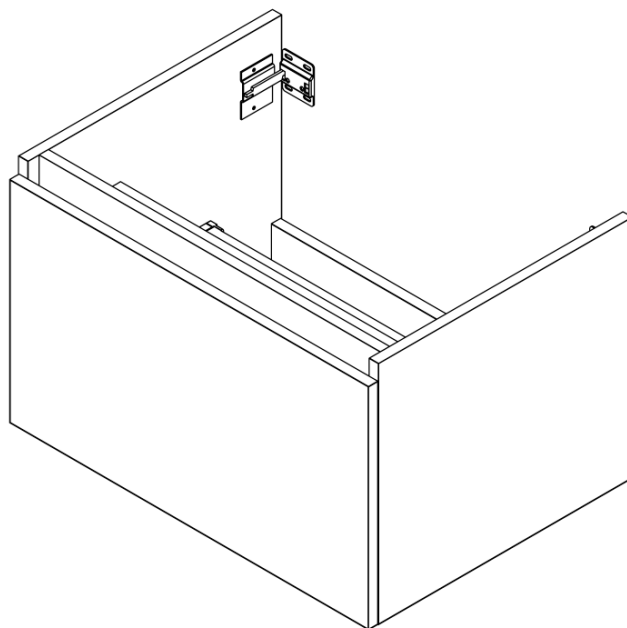

LOREA skrinka s dvojumývadlom 161x46x51,5cm
(70+20+70cm), dub alabama/biela matná

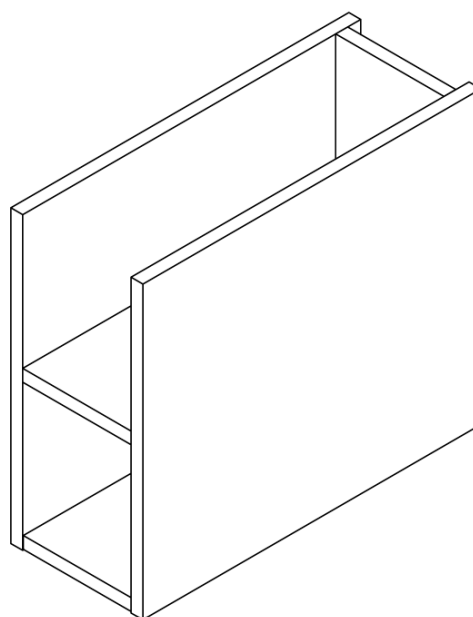
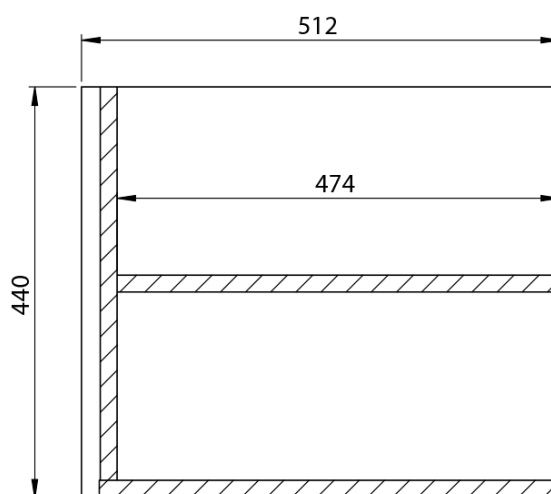
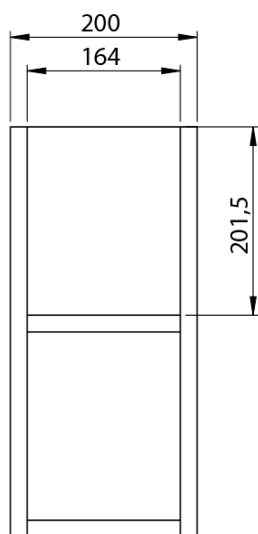

LOREA skrinka s dvojumývadlom 161x46x51,5cm
(70+20+70cm), dub alabama/biela matná

