

FORTIS obdĺžniková sprchová zástena 1500x900 mm, R varianta



Objednací kód: FL1115RFL3590

Základné informácie

Značka: Polysan

Séria: FORTIS

Rozmery

Šírka: 1500 mm

Výška: 2000 mm

Hĺbka: 900 mm

Vlastnosti

Farba profilu: Chróm - Leštený hliník

Tvar: Obdĺžnikové zásteny

Typ otvárania: Otváracie jednokrídlové

Smer otvárania: Pravé

Šírka vstupu: 565 mm

Typ výplne: Číre sklo

Úprava skla: Antidrop

Hrúbka skla: 8 mm

Vlastnosti: Bezrámové prevedenie

Hmotnosť / ks: 97.0 kg

Balenie: 2 ks

Záruka: 2 roky



Technický list



FORTIS obdĺžniková sprchová zástena 1500x900 mm, R varianta



Dveře	A (mm)	B (mm)	C (mm)
FL1080	785-801	≈ 200	779-795
FL1090	885-901	≈ 300	879-895
FL1010	985-1001	≈ 400	979-995
FL1011	1085-1101	≈ 500	1079-1095
FL1012	1185-1201	≈ 600	1179-1195
FL1113	1285-1301	≈ 700	1279-1295
FL1114	1385-1401	≈ 800	1379-1395
FL1115	1485-1501	≈ 900	1479-1495

Boční stěna	E	D
FL3580	785-801	779-795
FL3590	885-901	879-895
FL3510	985-1001	979-995

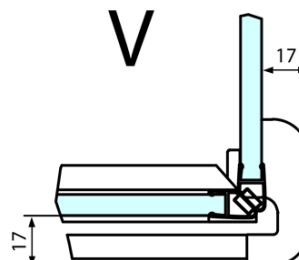

FORTIS obdížniková sprchová zástena 1500x900 mm, R varianta



Stavební připravenost pro montáž na dlažbu
kóty x, y = Rozměr k vnitřní straně skla

Construction readiness for floor mounting
dimensions x, y = Dimension to the inside of the glass



Dveře	X (mm)	B (mm)
FL1080	768	≈ 200
FL1090	868	≈ 300
FL1010	968	≈ 400
FL1011	1068	≈ 500
FL1012	1168	≈ 600
FL1113	1268	≈ 700
FL1114	1368	≈ 800
FL1115	1468	≈ 900

Boční stěna	Y
FL3580	768
FL3590	868
FL3510	968
FL3511	1068
FL3512	1168

