

Kod: ES1013

Rozmiary

Szerokość: 1267 mm

Wysokość: 2100 mm

Właściwości

Gwarancja: 3 lata



Karta techniczna

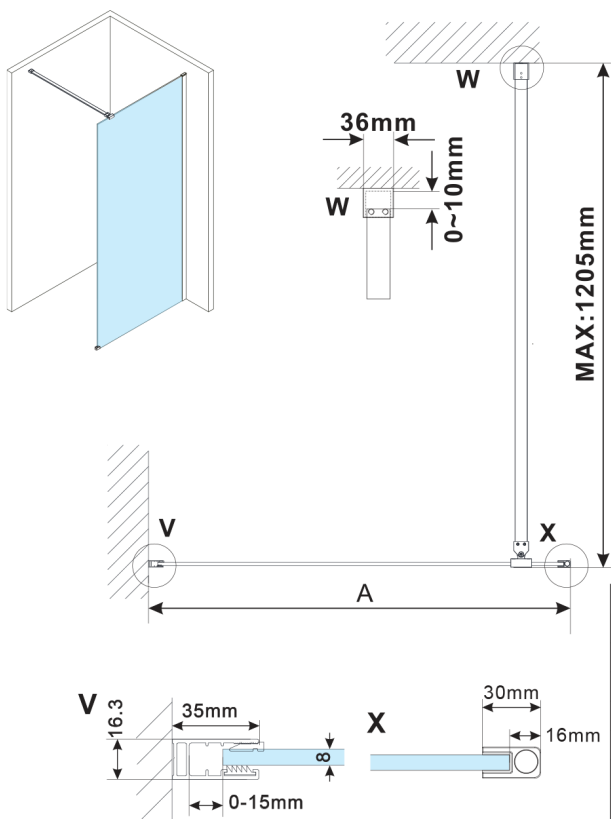

MODEL	A,mm
ES1070, ES1170, ES1270, ES1370, ES1570	690~705
ES1080, ES1180, ES1280, ES1380, ES1580	790~805
ES1090, ES1190, ES1290, ES1390, ES1590	890~905
ES1010, ES1110, ES1210, ES1310, ES1510	990~1005
ES1011, ES1111, ES1211, ES1311, ES1511	1090~1105
ES1012, ES1112, ES1212, ES1312, ES1512	1190~1205
ES1013, ES1113, ES1213, ES1313, ES1513	1290~1305
ES1014, ES1114, ES1214, ES1314, ES1514	1390~1405
ES1015, ES1115, ES1215, ES1315, ES1515	1490~1505

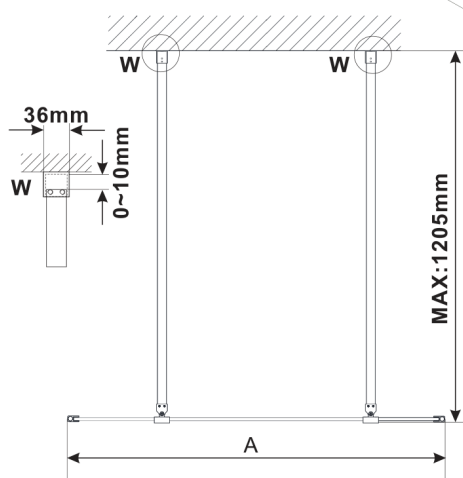
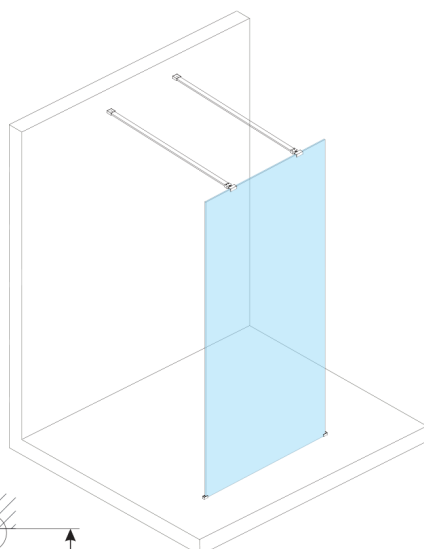

MODEL	A, mm
ES1070, ES1170, ES1270, ES1370, ES1570	699
ES1080, ES1180, ES1280, ES1380, ES1580	799
ES1090, ES1190, ES1290, ES1390, ES1590	899
ES1010, ES1110, ES1210, ES1310, ES1510	999
ES1011, ES1111, ES1211, ES1311, ES1511	1099
ES1012, ES1112, ES1212, ES1312, ES1512	1199
ES1013, ES1113, ES1213, ES1313, ES1513	1299
ES1014, ES1114, ES1214, ES1314, ES1514	1399
ES1015, ES1115, ES1215, ES1315, ES1515	1499

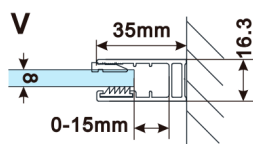
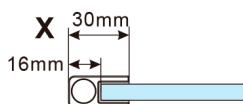
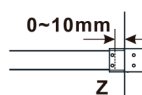
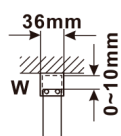
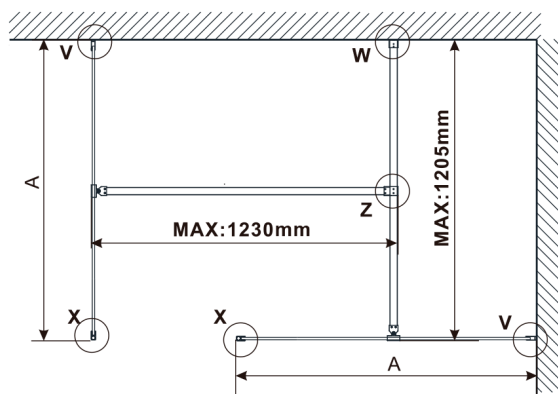
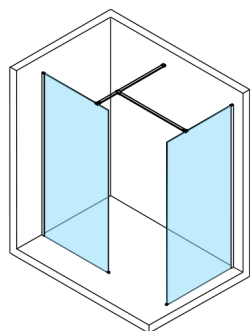
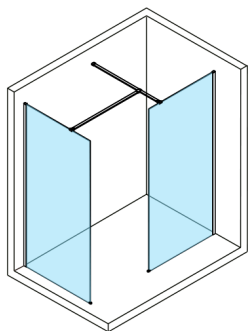

MODEL	A,mm
ES1070, ES1170, ES1270, ES1370, ES1570	690-705
ES1080, ES1180, ES1280, ES1380, ES1580	790-805
ES1090, ES1190, ES1290, ES1390, ES1590	890-905
ES1010, ES1110, ES1210, ES1310, ES1510	990-1005
ES1011, ES1111, ES1211, ES1311, ES1511	1090-1105
ES1012, ES1112, ES1212, ES1312, ES1512	1190-1205
ES1013, ES1113, ES1213, ES1313, ES1513	1290-1305
ES1014, ES1114, ES1214, ES1314, ES1514	1390-1405
ES1015, ES1115, ES1215, ES1315, ES1515	1490-1505