

## TRINITY CHROME rectangular screen 800x1000mm, matt glass, left

**Order code:** GT5610-80ML-CH

**Size**

Width: 800 mm  
 Height: 2000 mm  
 Depth: 1000 mm

**Properties**

Warranty: 3 years



### Technical sheet

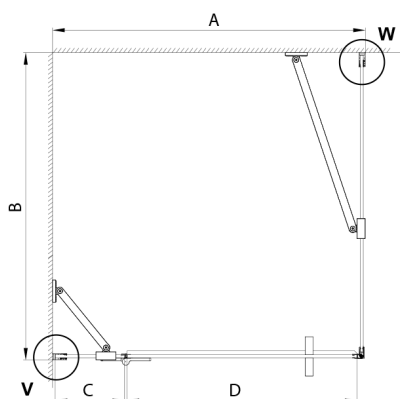

MODEL	A	B	C	D
800x800	785-800	785-800	167	585
800x900	785-800	885-900	167	585
800x1000	785-800	985-1000	167	585
800x1200	785-800	1185-1200	167	585
900x800	885-900	785-800	267	585
900x900	885-900	885-900	267	585
900x1000	885-900	985-1000	267	585
900x1200	885-900	1185-1200	267	585
1000x800	985-1000	785-800	367	585
1000x900	985-1000	885-900	367	585
1000x1000	985-1000	985-1000	367	585
1000x1200	985-1000	1185-1200	367	585
1100x800	1085-1100	785-800	467	585
1100x900	1085-1100	885-900	467	585
1100x1000	1085-1100	985-1000	467	585
1100x1200	1085-1100	1185-1200	467	585
1200x800	1185-1200	785-800	567	585
1200x900	1185-1200	885-900	567	585
1200x1000	1185-1200	985-1000	567	585
1200x1200	1185-1200	1185-1200	567	585

