

TRINITY CHROME rectangular screen 1200x900mm corner entry, matt glass

Order code: GT2290-12M-CH

Size

Width: 1200 mm
 Height: 2000 mm
 Depth: 900 mm

Properties

Warranty: 3 years



Technical sheet

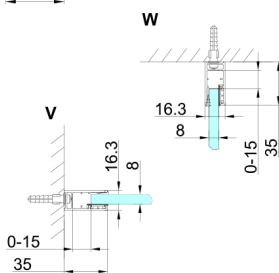
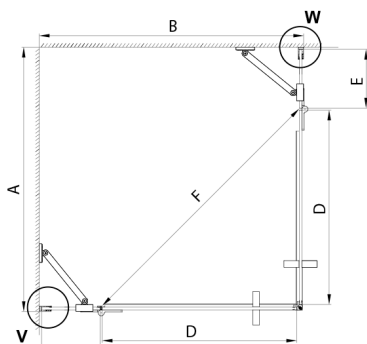
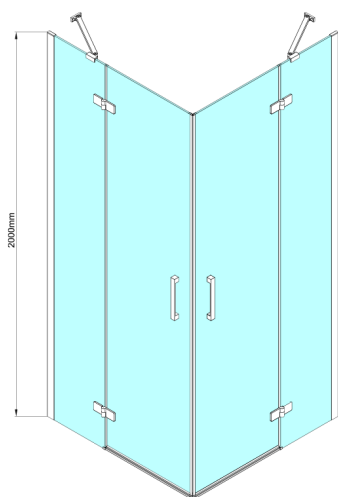

MODEL	A	B	C	D	E	F
800x800	785-800	785-800	167	585	167	840
800x900	785-800	885-900	267	585	167	840
800x1000	785-800	985-1000	367	585	167	840
800x1100	785-800	1085-1100	467	585	167	840
800x1200	785-800	1185-1200	567	585	167	840
900x900	885-900	885-900	267	585	267	840
900x1000	885-900	985-1000	367	585	267	840
900x1100	885-900	1085-1100	467	585	267	840
900x1200	885-900	1185-1200	567	585	267	840
1000x1000	985-1000	985-1000	367	585	367	840
1000x1100	985-1000	1085-1100	467	585	367	840
1000x1200	985-1000	1185-1200	567	585	367	840
1100x1100	1085-1100	1085-1100	467	585	467	840
1100x1200	1085-1100	1185-1200	567	585	467	840
1200x1200	1185-1200	1185-1200	567	585	567	840