

## LISA Whirlpool Bath, 150x70x47cm, Highline Hydro-Air, chrome

Order code: 85111.6010

### Size

Length: 1500 mm  
 Width: 700 mm  
 Height: 470 mm  
 Volume: 225 l



### Properties

Colour: White  
 Material: Acrylate  
 Warranty: 2 years

### Technical sheet

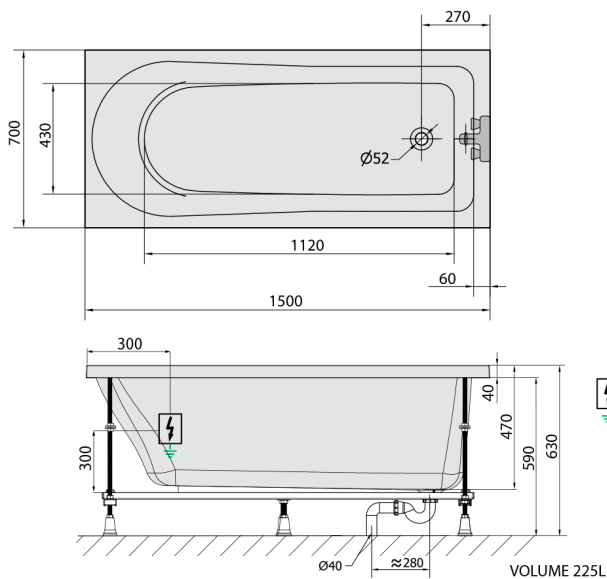

Electric cable 3x2,5mm<sup>2</sup>  
 Length 2m from the wall  
 Elektrický kabel 3x2,5mm<sup>2</sup>  
 Délka kabelu ze zdi 2m

Electrical Characteristic:  
 Tension: 220-230V/50hz  
 Max. power consumption: 1200W  
 Electric protection: residual-current device 30mA

Elektrické vlastnosti:  
 Napětí: 220-230V/50hz  
 Max. spotřeba: 1200W  
 Elektrické jistění: proudový chránič 30mA