

Order code: 90611.40

Basic information

Brand: Polysan

Size

Length: 1700 mm

Width: 800 mm

Height: 460 mm

Volume: 225 l

Properties

Colour: Beige

Material: Acrylate

Shape: Asymmetric

Installation: Built-in

Waste diameter: 52 mm

Properties: Edge height 40 mm (Standard)

Weight / Piece: 21.562 kg

Packaging: 1 Piece

Warranty: 10 years



We recommend buy

1 Piece Bath Trap 6/4", height: 42mm, DN40 (Order code: 71712)

1 Piece Sound insulation bath tape, 3m (Order code: 93400)

1 Piece Bath Support Legs for Acrylic Bath Polysan, 51,5cm, Pair (Order code: PO60-60)

Technical sheet

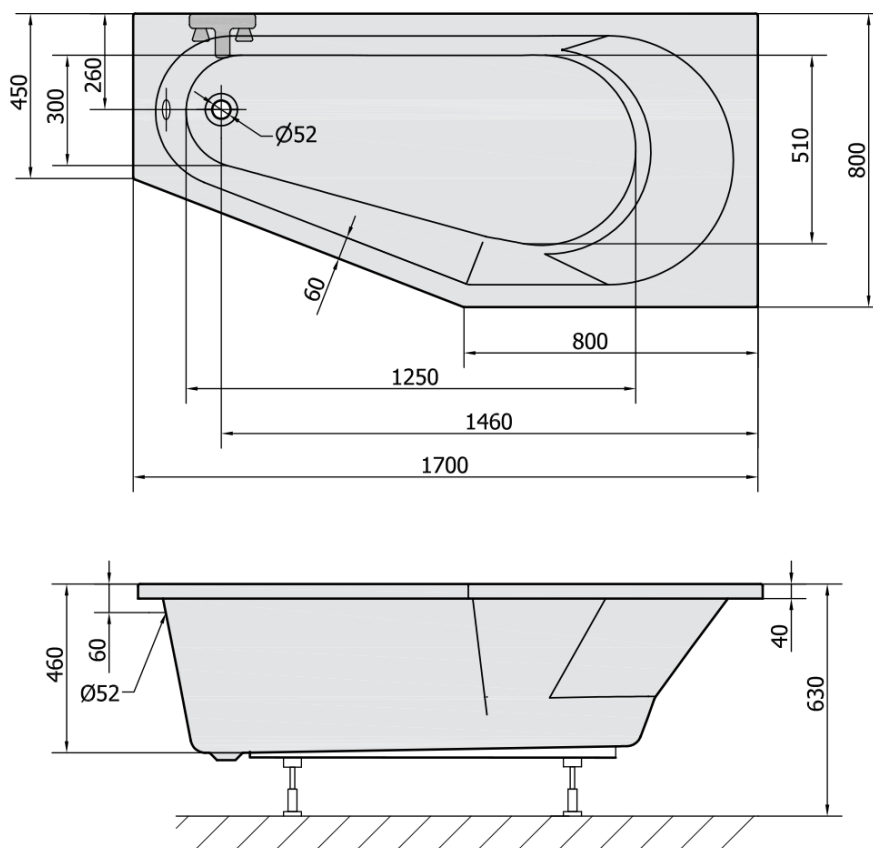

VOLUME 225L