

# ESCA BLACK MATT One-piece shower glass panel, wall-mount, smoked glass, 900 mm



**Order code:** ES1290-02

## Basic information

**Brand:** Polysan  
**Series:** ESCA

## Size

**Width:** 900 mm  
**Height:** 2100 mm

## Properties

**Profile colour:** Black matt  
**Shape:** Single-wall fixed screen  
**Glass colour:** Smoked glass  
**Glass finish:** Antidrop  
**Glass thickness:** 8 mm  
**Package does not contain:** Support bar  
**Weight / Piece:** 39.5 kg  
**Packaging:** 2 Piece  
**Warranty:** 2 years



**ESCA BLACK MATT One-piece shower glass panel,  
wall-mount, smoked glass, 900 mm**



**Technical sheet**

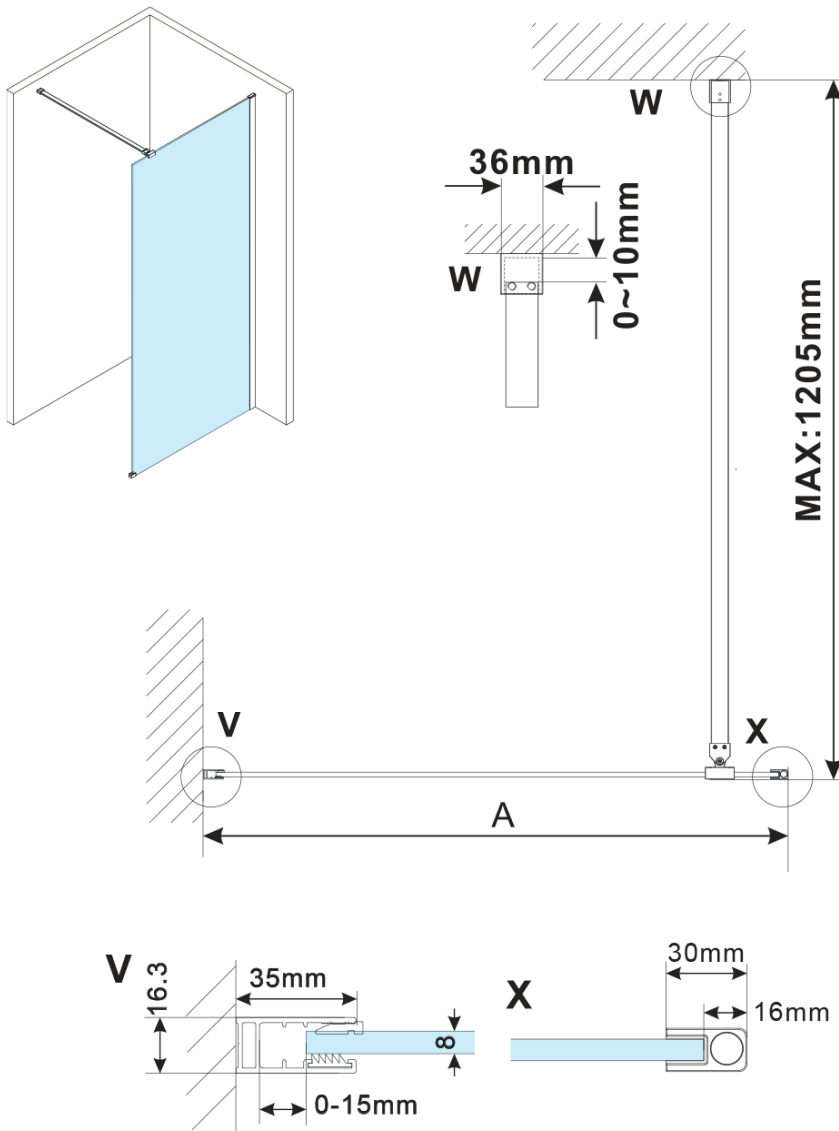

MODEL	A,mm
ES1070/ES1170/ES1270/ES1370/ES1570	690~705
ES1080/ES1180/ES1280/ES1380/ES1580	790~805
ES1090/ES1190/ES1290/ES1390/ES1590	890~905
ES1010/ES1110/ES1210/ES1310/ES1510	990~1005
ES1011/ES1111/ES1211/ES1311/ES1511	1090~1105
ES1012/ES1112/ES1212/ES1312/ES1512	1190~1205
ES1013/ES1113/ES1213/ES1313/ES1513	1290~1305
ES1014/ES1114/ES1214/ES1314/ES1514	1390~1405
ES1015/ES1115/ES1215/ES1315/ES1515	1490~1505

**ESCA BLACK MATT One-piece shower glass panel,  
wall-mount, smoked glass, 900 mm**

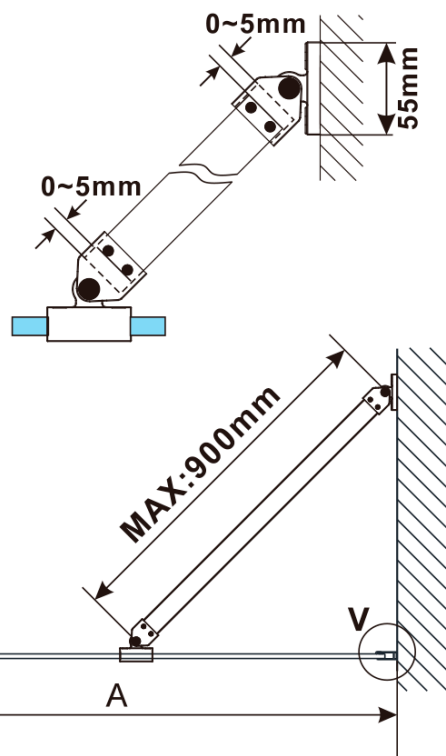

MODEL	A,mm
ES1070/ES1170/ES1270/ES1370/ES1570	690~705
ES1080/ES1180/ES1280/ES1380/ES1580	790~805
ES1090/ES1190/ES1290/ES1390/ES1590	890~905
ES1010/ES1110/ES1210/ES1310/ES1510	990~1005
ES1011/ES1111/ES1211/ES1311/ES1511	1090~1105
ES1012/ES1112/ES1212/ES1312/ES1512	1190~1205

