

NUBES towel holder 50cm, chrome



Order code: PANB52

Size
Length: 500 mm

Properties
Colour: Chrome
Warranty: 2 years

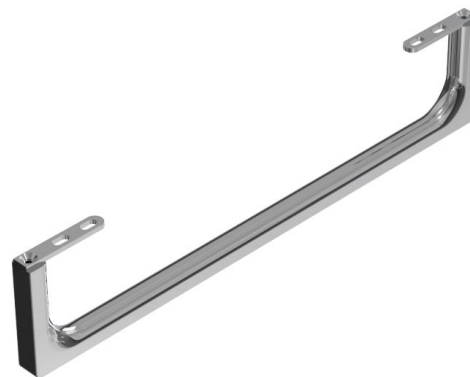

Technical sheet

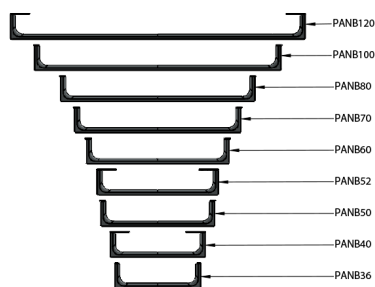
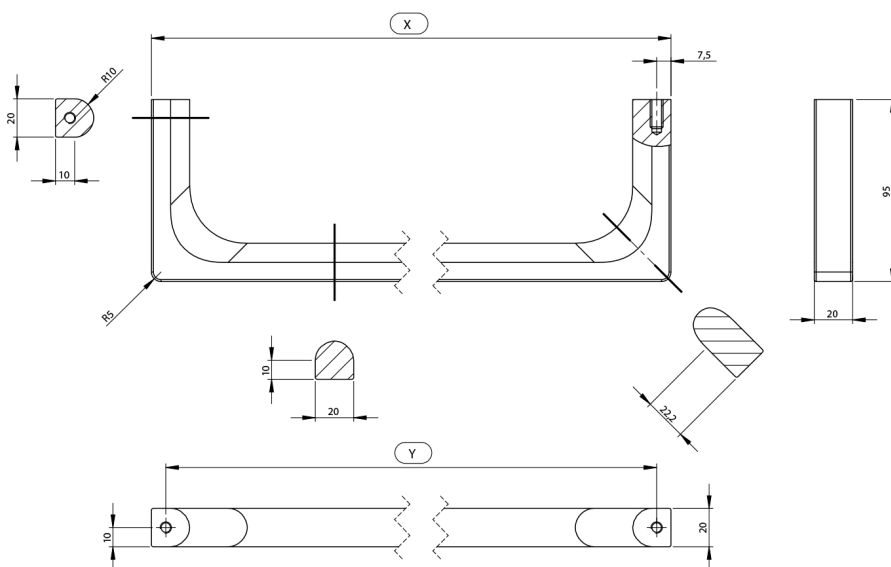

Varianta	X [mm]	Y [mm]
PANB120	1130	1115
PANB100	945	930
PANB80	745	730
PANB70	638	623
PANB60	548	533
PANB52	465	450
PANB50	438	423
PANB40	365	350
PANB36	330	315