

NUBES towel holder 50cm, black matt

GSI[®]

Order code: PANB50N

Basic information

Brand: GSI
Series: NUBES

Size

Length: 500 mm

Properties

Colour: Black
Weight / Piece: 0.65 kg
Packaging: 1 Piece
Warranty: 2 years



Technical sheet

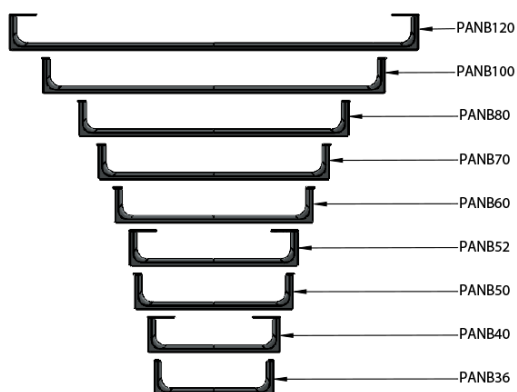
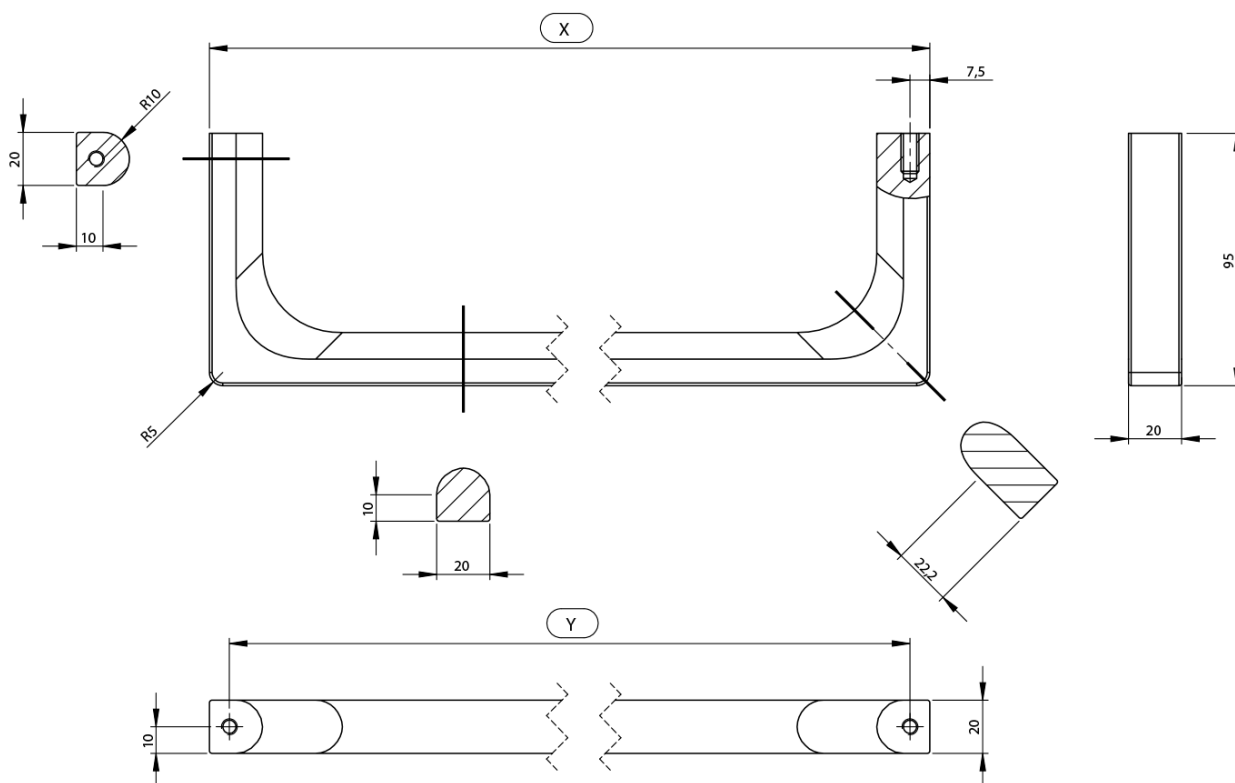

Varianta	X [mm]	Y [mm]
PANB120	1130	1115
PANB100	945	930
PANB80	745	730
PANB70	638	623
PANB60	548	533
PANB52	465	450
PANB50	438	423
PANB40	365	350
PANB36	330	315