

ESCA CHROME One-piece shower glass panel, wall-mount, matt glass, 1200 mm



Order code: ES1112-01

Basic information

Brand: Polysan
Series: ESCA

Size

Height: 2100 mm
Depth: 1200 mm

Properties

Profile colour: Chrome - polished aluminum
Shape: Single-wall fixed screen
Glass colour: Matte glass
Glass finish: Antidrop
Glass thickness: 8 mm
Weight / Piece: 68.0 kg
Packaging: 2 Piece
Warranty: 2 years



ESCA CHROME One-piece shower glass panel, wall-mount, matt glass, 1200 mm



Technical sheet



MODEL	A,mm
ES1070/ES1170/ES1270/ES1370/ES1570	690~705
ES1080/ES1180/ES1280/ES1380/ES1580	790~805
ES1090/ES1190/ES1290/ES1390/ES1590	890~905
ES1010/ES1110/ES1210/ES1310/ES1510	990~1005
ES1011/ES1111/ES1211/ES1311/ES1511	1090~1105
ES1012/ES1112/ES1212/ES1312/ES1512	1190~1205
ES1013/ES1113/ES1213/ES1313/ES1513	1290~1305
ES1014/ES1114/ES1214/ES1314/ES1514	1390~1405
ES1015/ES1115/ES1215/ES1315/ES1515	1490~1505

ESCA CHROME One-piece shower glass panel, wall-mount, matt glass, 1200 mm

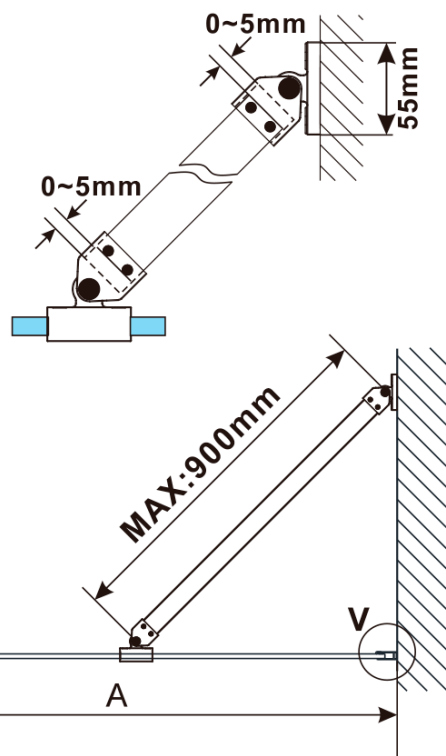

MODEL	A,mm
ES1070/ES1170/ES1270/ES1370/ES1570	690~705
ES1080/ES1180/ES1280/ES1380/ES1580	790~805
ES1090/ES1190/ES1290/ES1390/ES1590	890~905
ES1010/ES1110/ES1210/ES1310/ES1510	990~1005
ES1011/ES1111/ES1211/ES1311/ES1511	1090~1105
ES1012/ES1112/ES1212/ES1312/ES1512	1190~1205