

FORTIS EDGE alcove shower door 1200mm, clear glass, right



Order code: FL1612R

Basic information

Brand: Polysan
Series: FORTIS EDGE

Size

Width: 1200 mm
Height: 2000 mm

Properties

Profile colour: Chrome - polished aluminum
Shape: Alcove door
Type of opening: Single pivot door
Opening direction: Right
Opening width: 540 mm
Glass colour: TRANSPARENT glass
Glass finish: Antidrop
Glass thickness: 8 mm
Installation width from: 1190 mm
Installation width up to: 1205 mm
Properties: Frameless design
Weight / Piece: 74.0 kg
Packaging: 1 Piece
Warranty: 2 years



Spare parts

Acrylic seal glass/floor (shower tray), length 1000mm for 8mm glass (Order code: 309D-08)
Acrylic gasket between glass 8mm, flag (Order code: NDFL0503)
FORTIS magnet FORTIS, 1ks (Order code: NDFL0342)

FORTIS EDGE alcove shower door 1200mm, clear glass, right

Technical sheet

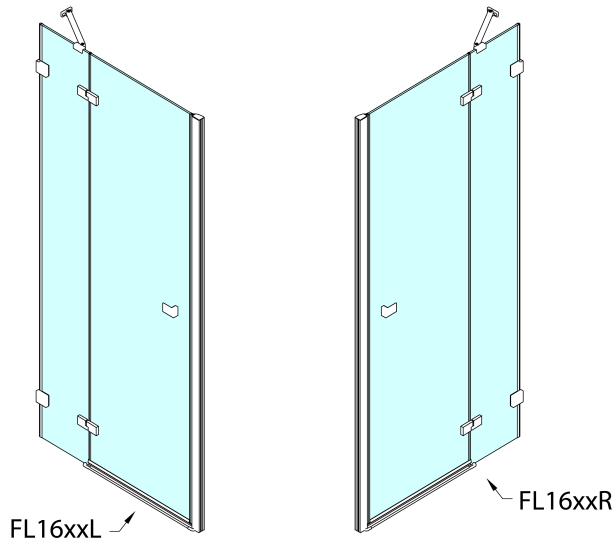

	A (mm)	B (mm)
FL1680	790-805	≈ 190
FL1690	890-905	≈ 290
FL1610	990-1005	≈ 390
FL1611	1090-1105	≈ 490
FL1612	1190-1205	≈ 590

CZ: Stavební připravenost pro montáž na dlažbu kóty A= vzdálenost mezi zdmi.

EN: Construction readiness for floor mounting dimension A= distance between walls.

