

NUBES towel holder 80cm, black matt

GSI[®]

Order code: PANB80N

Basic information

Brand: GSI
Series: NUBES

Size

Length: 800 mm

Properties

Colour: Black
Weight / Piece: 1.0 kg
Packaging: 1 Piece
Warranty: 2 years

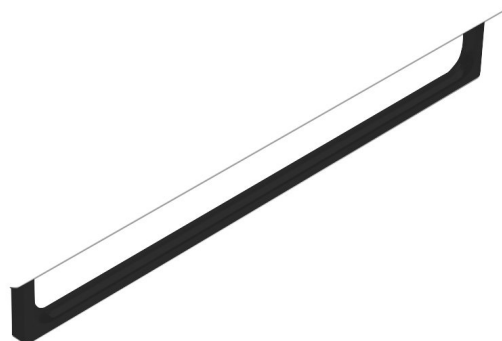

Technical sheet

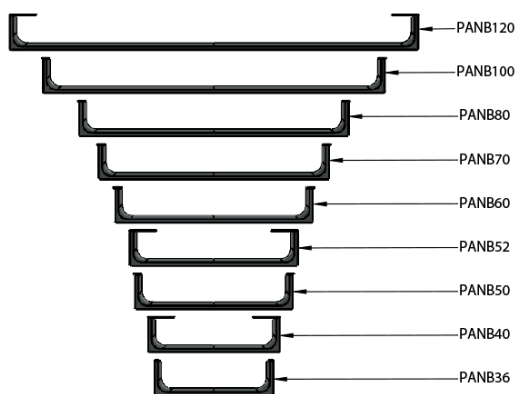
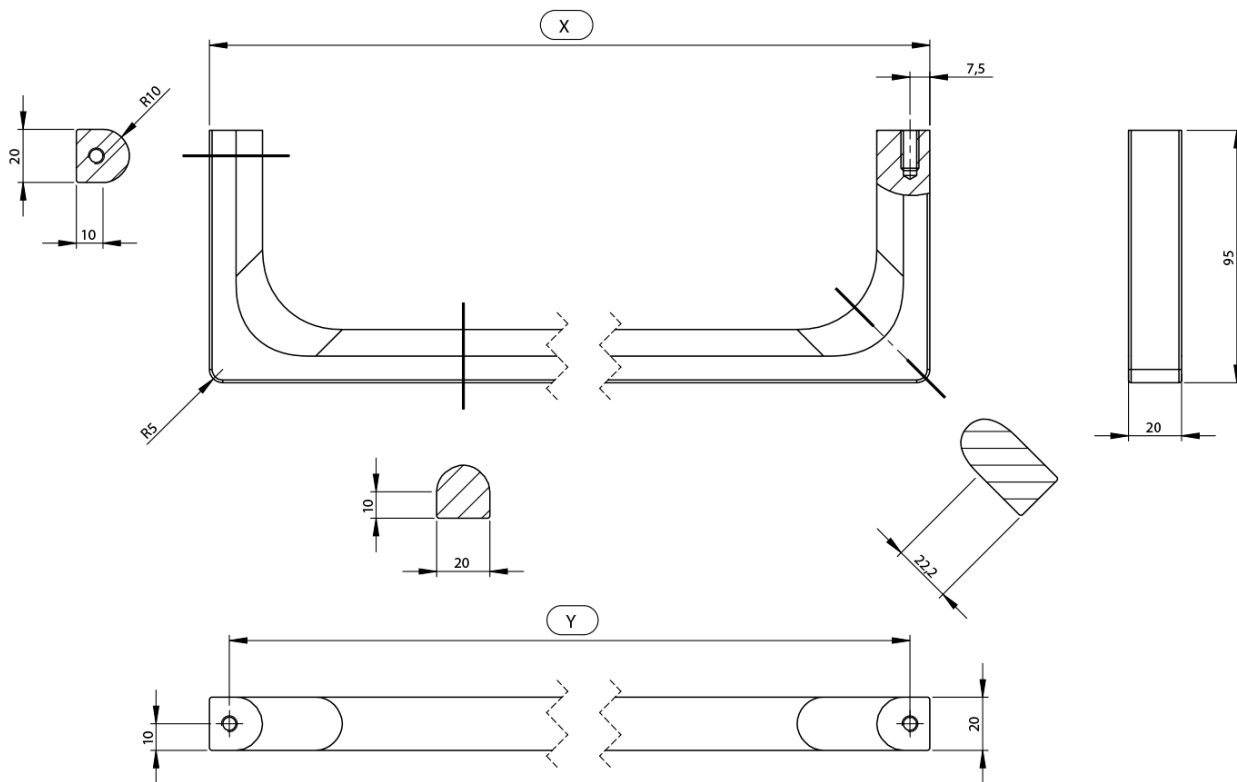

Varianta	X [mm]	Y [mm]
PANB120	1130	1115
PANB100	945	930
PANB80	745	730
PANB70	638	623
PANB60	548	533
PANB52	465	450
PANB50	438	423
PANB40	365	350
PANB36	330	315