

NUBES towel holder 36cm, black matt

GSI[®]

Order code: PANB36N

Basic information

Brand: GSI
Series: NUBES

Size

Length: 360 mm

Properties

Colour: Black
Weight / Piece: 0.6 kg
Packaging: 1 Piece
Warranty: 2 years



Technical sheet

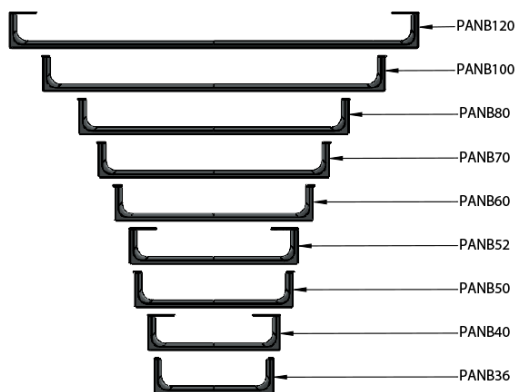
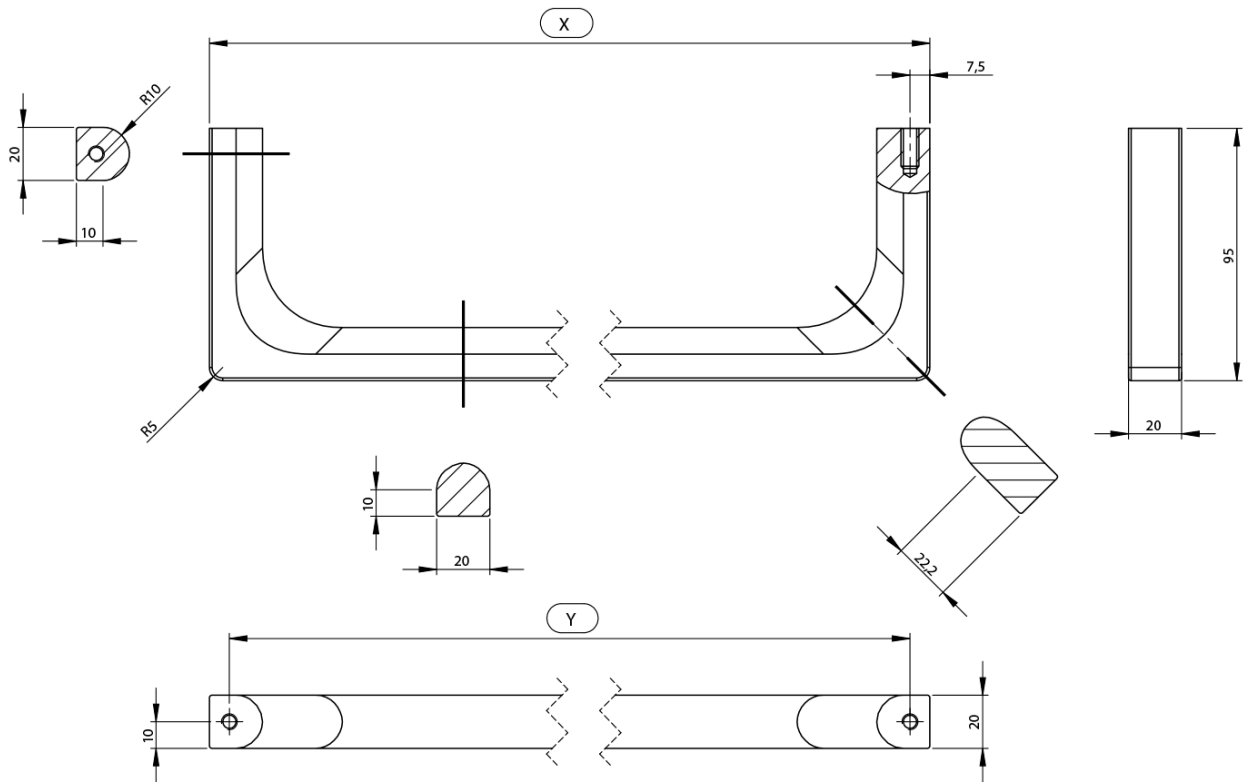

| Varianta | X [mm] | Y [mm] |
|----------|--------|--------|
| PANB120 | 1130 | 1115 |
| PANB100 | 945 | 930 |
| PANB80 | 745 | 730 |
| PANB70 | 638 | 623 |
| PANB60 | 548 | 533 |
| PANB52 | 465 | 450 |
| PANB50 | 438 | 423 |
| PANB40 | 365 | 350 |
| PANB36 | 330 | 315 |