

## SPITZA shower enclosure WALK-IN, 1000mm

**BRUCKNER**

**Order code:** 750.100.1

### Basic information

**Brand:** Bruckner  
**Series:** SPITZA

### Size

**Height:** 2000 mm  
**Depth:** 1000 mm

### Properties

**Profile colour:** Chrome - polished aluminum  
**Shape:** Single-wall fixed screen  
**Glass colour:** TRANSPARENT glass  
**Glass thickness:** 8 mm  
**Weight / Piece:** 42.2 kg  
**Packaging:** 1 Piece  
**Warranty:** 2 years



Technical sheet

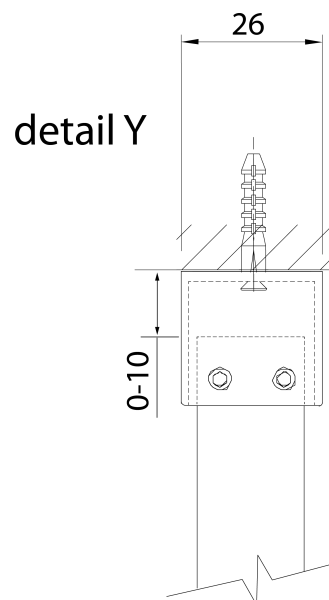
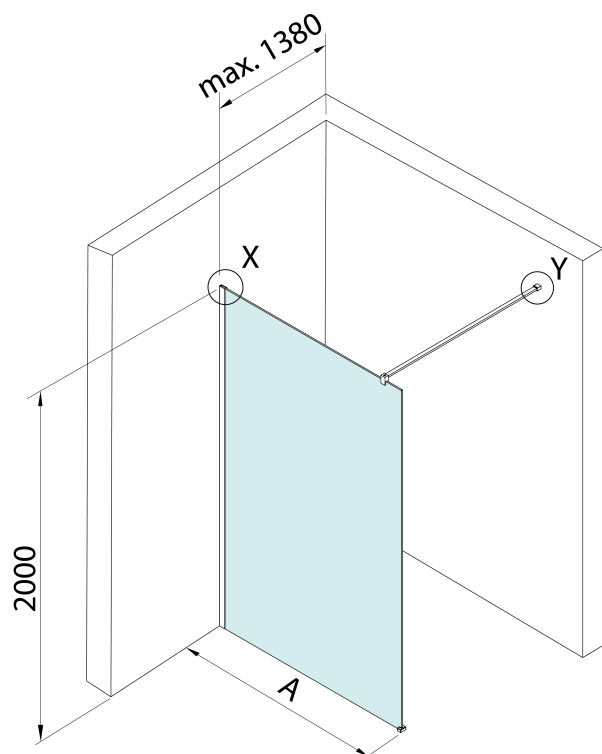

detail X

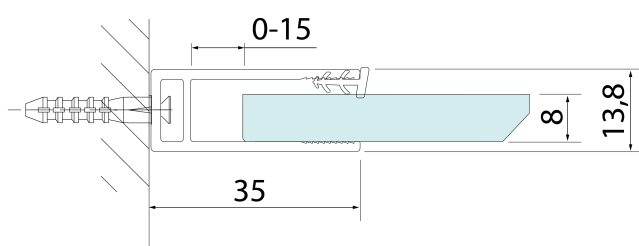

MODEL	A
750.080.1	785-800
750.090.1	885-900
750.100.1	985-1000
750.110.1	1085-1100
750.120.1	1185-1200