

## NUBES towel holder 40cm, chrome

GSI<sup>®</sup>

Order code: PANB40

### Basic information

Brand: GSI  
Series: NUBES

### Size

Length: 400 mm

### Properties

Colour: Chrome  
Weight / Piece: 0.6 kg  
Packaging: 1 Piece  
Warranty: 2 years



Technical sheet

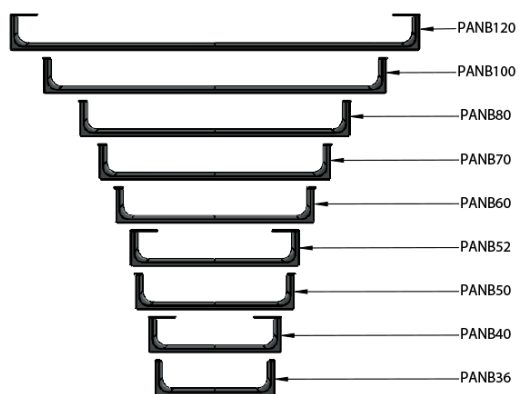
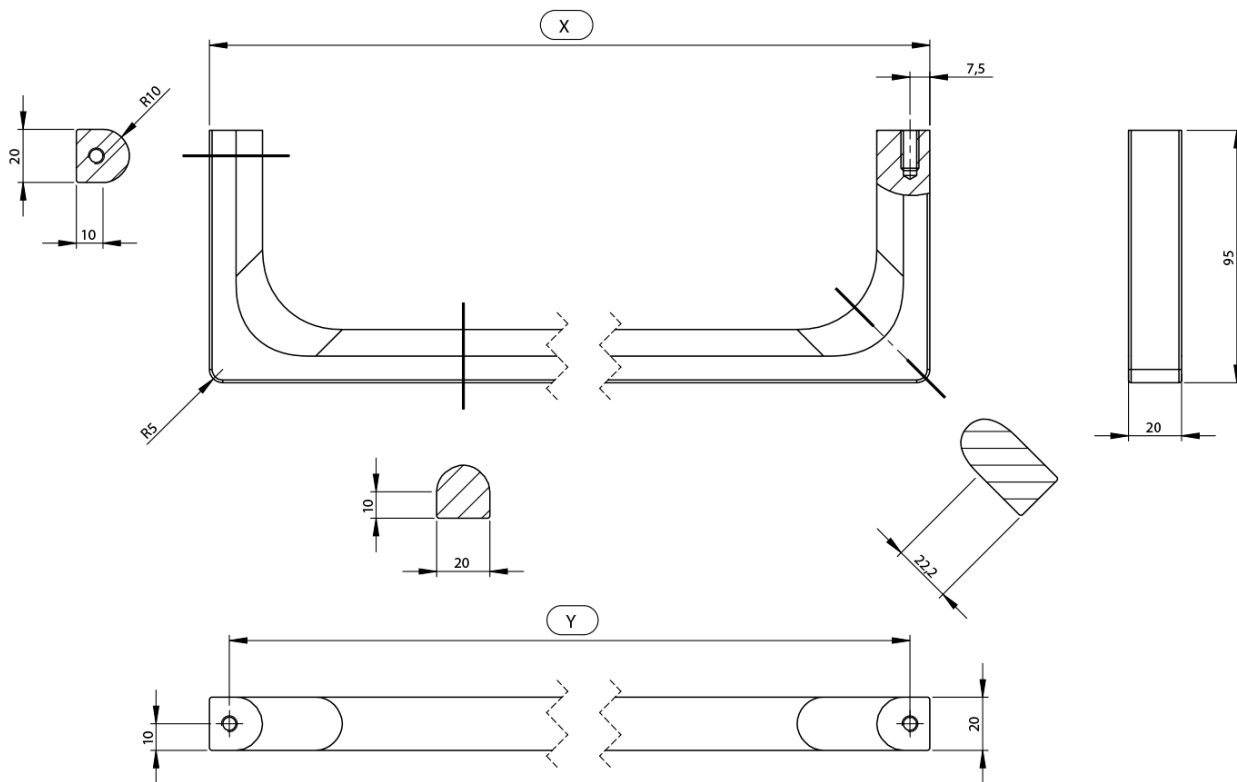

Varianta	X [mm]	Y [mm]
PANB120	1130	1115
PANB100	945	930
PANB80	745	730
PANB70	638	623
PANB60	548	533
PANB52	465	450
PANB50	438	423
PANB40	365	350
PANB36	330	315