

ROLLS Rectangular screen 1600x900 mm, L/R variant, clear glass



Order code: RL1615RL3315

Basic information

Brand: Polysan
Series: ROLLS

Size

Width: 1600 mm
Height: 2000 mm
Depth: 900 mm

Properties

Profile colour: Chrome - polished aluminum
Shape: Rectangular shower enclosures
Type of opening: Sliding door
Opening direction: Versatile
Opening width: 675 mm
Glass colour: TRANSPARENT glass
Glass finish: Antidrop
Glass thickness: 8 mm
Properties: Frameless design
Weight / Piece: 77.0 kg
Packaging: 2 Piece
Warranty: 2 years



Spare parts

ALTIS/ROLLS/DRAGON set of screw covers (Order code: NDAL03)
Flat magnetic seal for glass 8mm, 2000mm (Order code: NDGV02)
ROLLS handle (Order code: NDRL-MADLO)
Bottom seal under solid glass 8mm, 1000mm (Order code: NDRL03)
Vertical seal for 8mm glass, 2000mm (Order code: NDRL02)
ROLLS L/P ends of the roller profile (Order code: NDRL05)
Bottom seal for glass 8mm, 1000 mm, (Order code: NDRL01)
ROLLS roller profile (Order code: NDRL04)

ROLLS Rectangular screen 1600x900 mm, L/R
variant, clear glass

Technical sheet

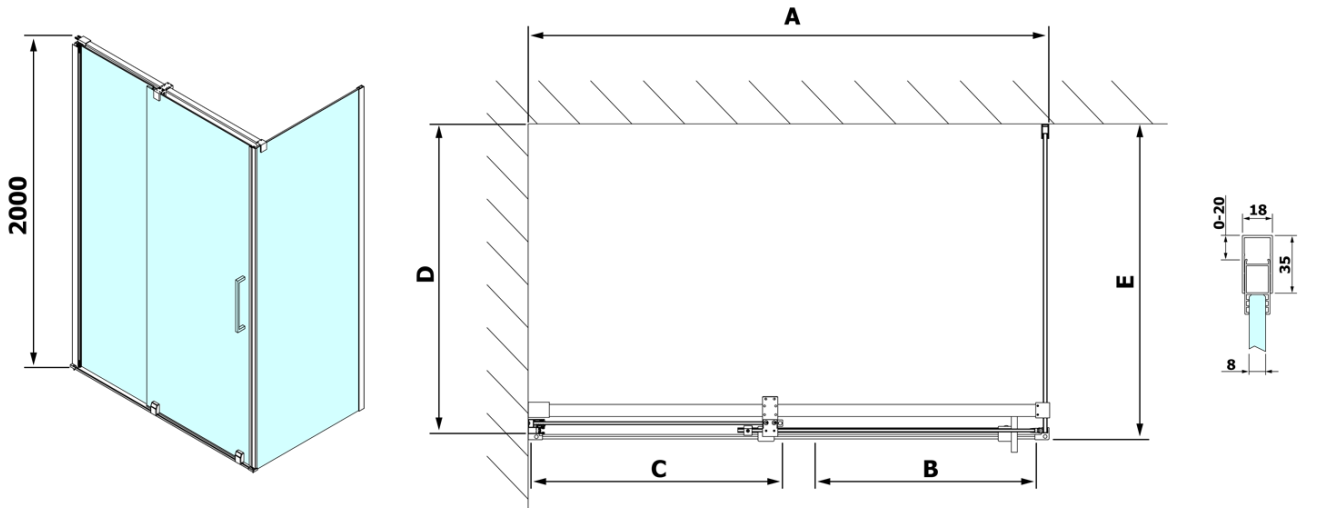

Model	D	E
RL3215	765-785	780-800
RL3315	865-885	880-900
RL3415	965-985	980-1000

Model	A	B	C
RL1115	1070-1110	425	~500
RL1215	1170-1210	475	~550
RL1315	1270-1310	525	~600
RL1415	1370-1410	575	~650
RL1515	1470-1510	625	~700
RL1615	1570-1610	675	~750

