

ROLLS Rectangular screen 1500x900 mm, L/R variant, clear glass



Order code: RL1515RL3315

Basic information

Brand: Polysan

Series: ROLLS

Size

Width: 1500 mm

Height: 2000 mm

Depth: 900 mm

Properties

Profile colour: Chrome - polished aluminum

Shape: Rectangular shower enclosures

Type of opening: Sliding door

Opening direction: Versatile

Opening width: 625 mm

Glass colour: TRANSPARENT glass

Glass finish: Antidrop

Glass thickness: 8 mm

Properties: Frameless design

Weight / Piece: 75.0 kg

Packaging: 2 Piece

Warranty: 2 years



Spare parts

ALTIS/ROLLS/DRAGON set of screw covers (Order code: NDAL03)

ROLLS bottom seal under solid glass (Order code: NDRL03)

ROLLS handle (Order code: NDRL-MADLO)

VOLCANO/ROLLS LINE magnetic seal (Order code: NDGV02)

ROLLS L/P ends of the roller profile (Order code: NDRL05)

ROLLS vertical seal (Order code: NDRL02)

ROLLS Bottom seal (Order code: NDRL01)

ROLLS roller profile (Order code: NDRL04)

ROLLS Rectangular screen 1500x900 mm, L/R
variant, clear glass



Technical sheet

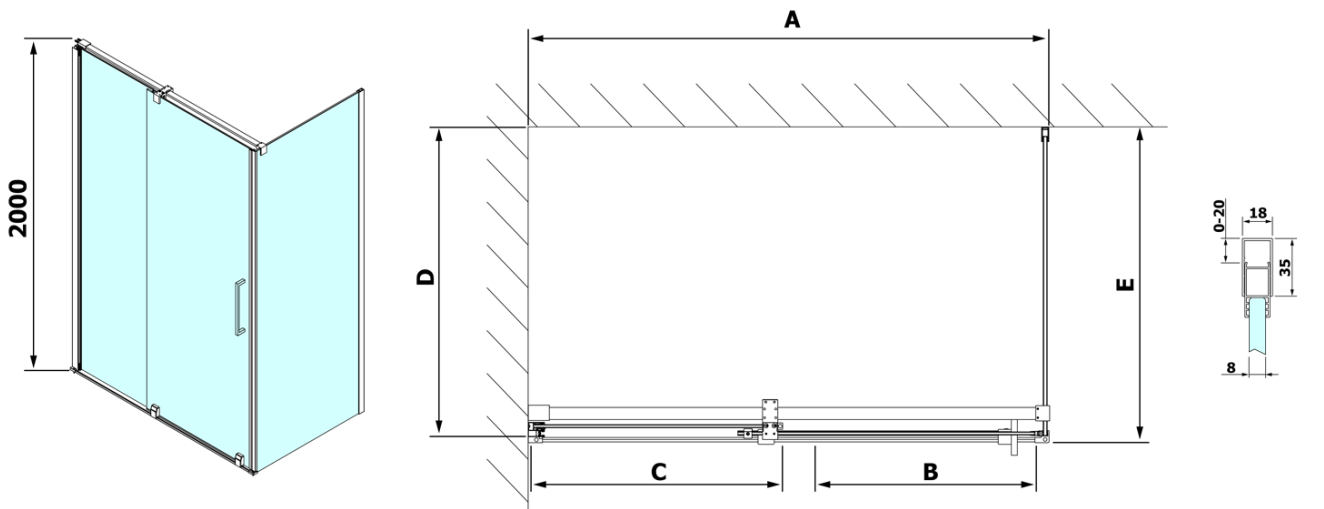

Model	D	E
RL3215	765-785	780-800
RL3315	865-885	880-900
RL3415	965-985	980-1000

Model	A	B	C
RL1115	1070-1110	425	~500
RL1215	1170-1210	475	~550
RL1315	1270-1310	525	~600
RL1415	1370-1410	575	~650
RL1515	1470-1510	625	~700
RL1615	1570-1610	675	~750

