

ROLLS shower door 1400mm, height 2000mm, clear glass



Order code: RL1415

Basic information

Brand: Polysan

Series: ROLLS

Size

Width: 1400 mm

Height: 2000 mm

Properties

Profile colour: Chrome - polished aluminum

Shape: Alcove door

Type of opening: Sliding door

Opening direction: Versatile

Opening width: 575 mm

Glass colour: TRANSPARENT glass

Glass finish: Antidrop

Glass thickness: 8 mm

Installation width from: 1370 mm

Installation width up to: 1410 mm

Properties: Frameless design

Weight / Piece: 65.0 kg

Warranty: 2 years



Spare parts

ALTIS/ROLLS/DRAGON set of screw covers (Order code: NDAL03)

Flat magnetic seal for glass 8mm, 2000mm (Order code: NDGV02)

Bottom seal under solid glass 8mm, 1000mm (Order code: NDRL03)

ROLLS handle (Order code: NDRL-MADLO)

ROLLS L/P ends of the roller profile (Order code: NDRL05)

Vertical seal for 8mm glass, 2000mm (Order code: NDRL02)

Bottom seal for glass 8mm, 1000 mm, (Order code: NDRL01)

ROLLS roller profile (Order code: NDRL04)

ROLLS shower door 1400mm, height 2000mm, clear glass

Technical sheet

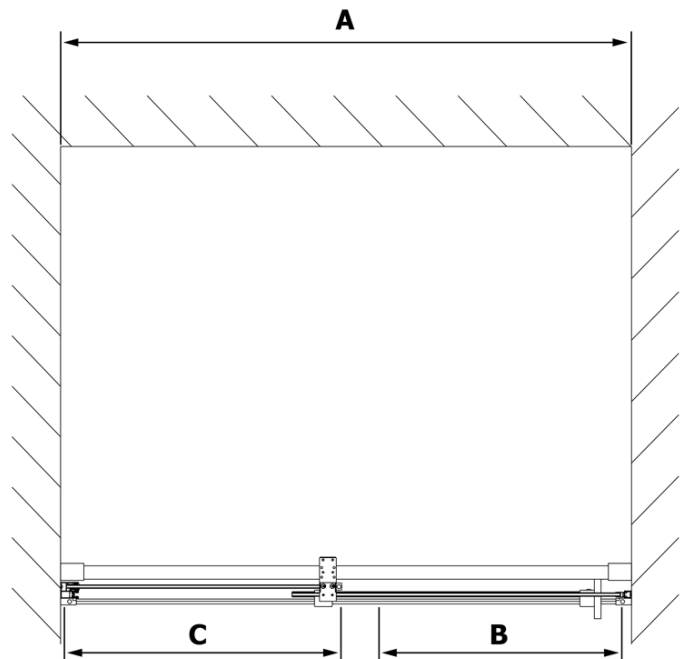
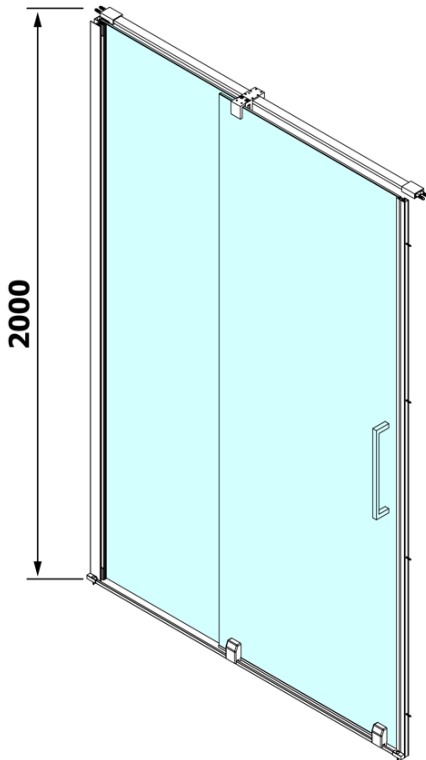

MODEL	A	B	C
RL1115	1070-1110	425	~500
RL1215	1170-1210	475	~550
RL1315	1270-1310	525	~600
RL1415	1370-1410	575	~650
RL1515	1470-1510	625	~700
RL1615	1570-1610	675	~750

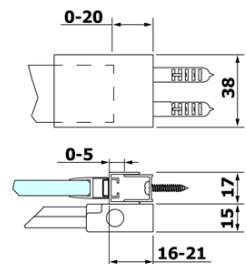
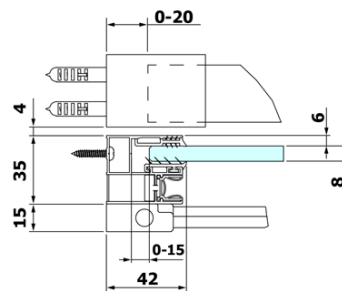

ROLLS shower door 1400mm, height 2000mm, clear glass

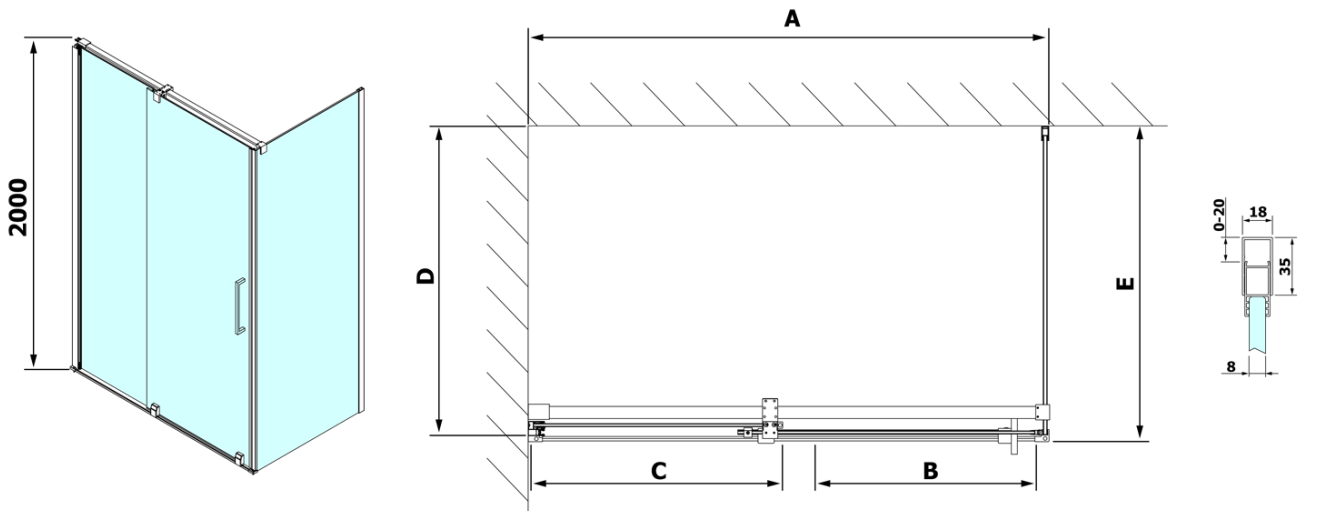

Model	D	E
RL3215	765-785	780-800
RL3315	865-885	880-900
RL3415	965-985	980-1000

Model	A	B	C
RL1115	1070-1110	425	~500
RL1215	1170-1210	475	~550
RL1315	1270-1310	525	~600
RL1415	1370-1410	575	~650
RL1515	1470-1510	625	~700
RL1615	1570-1610	675	~750

