

**Order code:** AL4215CAL6115C

## Basic information

**Brand:** Polysan  
**Series:** ALTIS

## Size

**Width:** 1500 mm  
**Height:** 2000 mm  
**Depth:** 1000 mm

## Properties

**Profile colour:** Chrome - polished aluminum  
**Shape:** Rectangular shower enclosures  
**Type of opening:** Sliding door  
**Opening direction:** Versatile  
**Opening width:** 625 mm  
**Glass colour:** TRANSPARENT glass  
**Glass finish:** Antidrop  
**Glass thickness:** 8 mm  
**Properties:** Frameless design  
**Weight / Piece:** 79.0 kg  
**Packaging:** 2 Piece  
**Warranty:** 2 years



## Spare parts

Set of 45° magnetic seals for glass 8mm and profile , 2000mm (Order code: NDGD03)

ALTIS handle (Order code: NDAL-MADLO)

Set of 45° magnetic seals for glass 8/8mm, 2000mm (Order code: NDTL04)

ALTIS installation set (Order code: NDAL01)

Bottom seal for door, glass 8mm, 1000mm (Order code: NDGD02)

Bubble Seal for 8mm Glass, 1963mm (Order code: NDAL02)

ALTIS roller (Order code: NDAL04)

Set of vertical seals for 8/8mm glass, 2000mm (Order code: NDAL06)

ALTIS/ROLLS/DRAGON set of screw covers (Order code: NDAL03)

Technical sheet

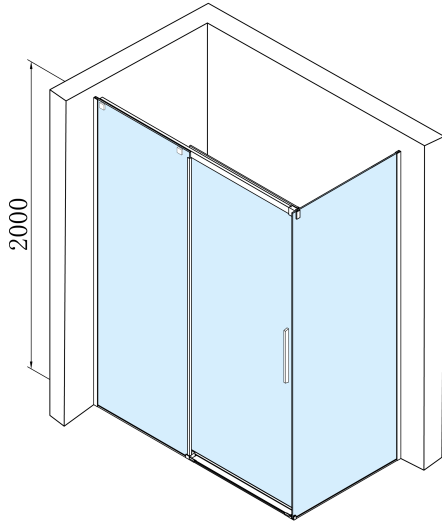

MODEL	A	B	C
AL3915C	1082-1122	498	425
AL3015C	1182-1222	548	475
AL4015C	1282-1322	598	525
AL4115C	1382-1422	648	575
AL4215C	1482-1522	698	625
AL4315C	1582-1622	748	675

MODEL	D
AL5915C	780-800
AL6015C	880-900
AL6115C	980-1000

