

Order code: AL4015CAL5915C

Basic information

Brand: Polysan

Series: ALTIS

Size

Width: 1300 mm

Height: 2000 mm

Depth: 800 mm

Properties

Profile colour: Chrome - polished aluminum

Shape: Rectangular shower enclosures

Type of opening: Sliding door

Opening direction: Versatile

Opening width: 525 mm

Glass colour: TRANSPARENT glass

Glass finish: Antidrop

Glass thickness: 8 mm

Properties: Frameless design

Weight / Piece: 95.0 kg

Packaging: 2 Piece

Warranty: 2 years



Spare parts

Set of 45° magnetic seals for glass 8mm and profile , 2000mm (Order code: NDGD03)

ALTIS handle (Order code: NDAL-MADLO)

Set of 45° magnetic seals for glass 8/8mm, 2000mm (Order code: NDTL04)

ALTIS installation set (Order code: NDAL01)

Bottom seal for door, glass 8mm, 1000mm (Order code: NDGD02)

Bubble Seal for 8mm Glass, 1963mm (Order code: NDAL02)

ALTIS roller (Order code: NDAL04)

Set of vertical seals for 8/8mm glass, 2000mm (Order code: NDAL06)

ALTIS/ROLLS/DRAGON set of screw covers (Order code: NDAL03)

Technical sheet

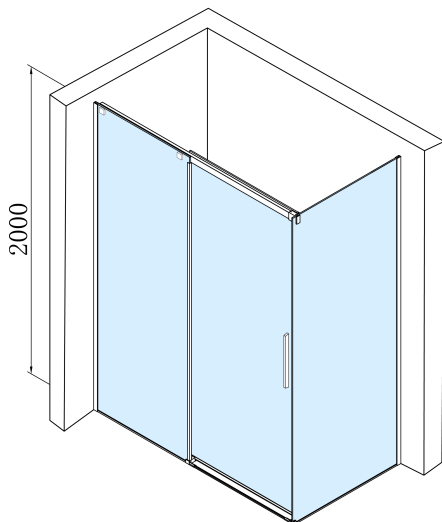

MODEL	A	B	C
AL3915C	1082-1122	498	425
AL3015C	1182-1222	548	475
AL4015C	1282-1322	598	525
AL4115C	1382-1422	648	575
AL4215C	1482-1522	698	625
AL4315C	1582-1622	748	675

MODEL	D
AL5915C	780-800
AL6015C	880-900
AL6115C	980-1000

