

Order code: AL3915CAL6115C

Basic information

Brand: Polysan
Series: ALTIS

Size

Width: 1100 mm
Height: 2000 mm
Depth: 1000 mm

Properties

Profile colour: Chrome - polished aluminum
Shape: Rectangular shower enclosures
Type of opening: Sliding door
Opening direction: Versatile
Opening width: 425 mm
Glass colour: TRANSPARENT glass
Glass finish: Antidrop
Glass thickness: 8 mm
Properties: Frameless design
Weight / Piece: 93.0 kg
Packaging: 2 Piece
Warranty: 2 years



Spare parts

Set of 45° magnetic seals for glass 8mm and profile , 2000mm (Order code: NDGD03)

ALTIS handle (Order code: NDAL-MADLO)

Set of 45° magnetic seals for glass 8/8mm, 2000mm (Order code: NDTL04)

ALTIS installation set (Order code: NDAL01)

Bottom seal for door, glass 8mm, 1000mm (Order code: NDGD02)

Bubble Seal for 8mm Glass, 1963mm (Order code: NDAL02)

ALTIS roller (Order code: NDAL04)

Set of vertical seals for 8/8mm glass, 2000mm (Order code: NDAL06)

ALTIS/ROLLS/DRAGON set of screw covers (Order code: NDAL03)

Technical sheet

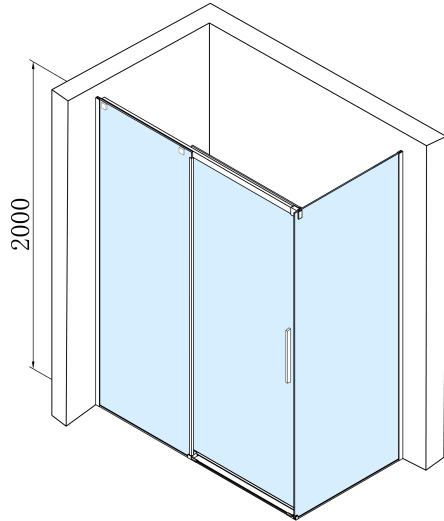

MODEL	A	B	C
AL3915C	1082-1122	498	425
AL3015C	1182-1222	548	475
AL4015C	1282-1322	598	525
AL4115C	1382-1422	648	575
AL4215C	1482-1522	698	625
AL4315C	1582-1622	748	675

MODEL	D
AL5915C	780-800
AL6015C	880-900
AL6115C	980-1000

