

# EASY screen three sides 1600x900mm, L/R variant, clear glass



**Order code:** EL1815EL3315EL3315

## Basic information

**Brand:** Polysan  
**Series:** EASY

## Size

**Width:** 1600 mm  
**Height:** 1900 mm  
**Depth:** 900 mm

## Properties

**Profile colour:** Chrome - polished aluminum  
**Shape:** 3-piece shower enclosures  
**Type of opening:** Sliding door  
**Opening direction:** Versatile  
**Opening width:** 680 mm  
**Glass colour:** TRANSPARENT glass  
**Glass thickness:** 6 mm  
**Properties:** Framed design  
**Weight / Piece:** 106.0 kg  
**Packaging:** 5 Piece  
**Warranty:** 2 years



EASY screen three sides 1600x900mm, L/R variant, clear glass

Technical sheet



EL1015L  
EL1115L  
EL1215L  
EL1315L  
EL1415L  
EL1515L  
EL1815L

EL3115  
EL3215  
EL3315  
EL3415



EL3115  
EL3215  
EL3315  
EL3415

EL1015R  
EL1115R  
EL1215R  
EL1315R  
EL1415R  
EL1515R  
EL1815R

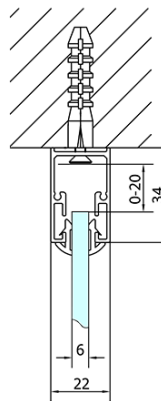
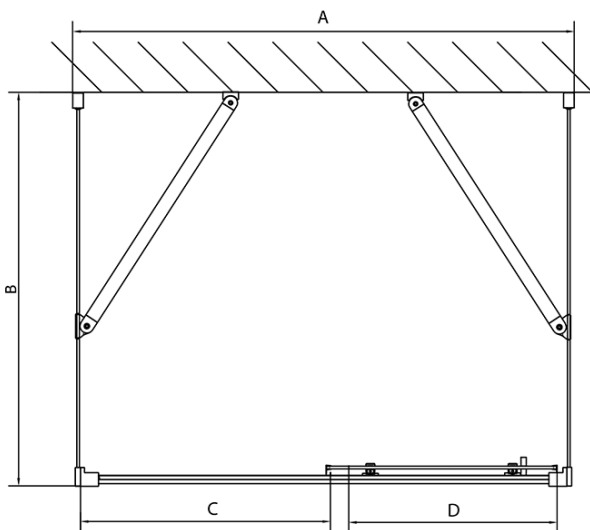

	B
EL3115	680-700
EL3215	780-800
EL3315	880-900
EL3415	980-1000

	A	C	D
EL1015	990-1030	470	400
EL1115	1090-1130	500	430
EL1215	1190-1230	530	480
EL1315	1290-1330	590	530
EL1415	1390-1430	640	580
EL1515	1490-1530	690	630
EL1815	1590-1630	740	680