

EASY screen three sides 1600x900mm, L/R variant, clear glass



Order code: EL1815EL3315EL3315

Basic information

Brand: Polysan
Series: EASY

Size

Width: 1600 mm
Height: 1900 mm
Depth: 900 mm

Properties

Profile colour: Chrome - polished aluminum
Shape: 3-piece shower enclosures
Type of opening: Sliding door
Opening direction: Versatile
Opening width: 680 mm
Glass colour: TRANSPARENT glass
Glass thickness: 6 mm
Properties: Framed design
Weight / Piece: 106.0 kg
Packaging: 5 Piece
Warranty: 2 years



EASY screen three sides 1600x900mm, L/R variant, clear glass



Technical sheet



EL1015L
EL1115L
EL1215L
EL1315L
EL1415L
EL1515L
EL1815L

EL3115
EL3215
EL3315
EL3415



EL3115
EL3215
EL3315
EL3415

EL1015R
EL1115R
EL1215R
EL1315R
EL1415R
EL1515R
EL1815R

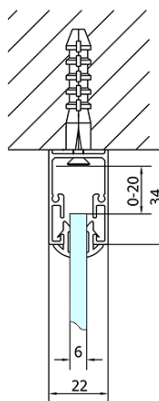
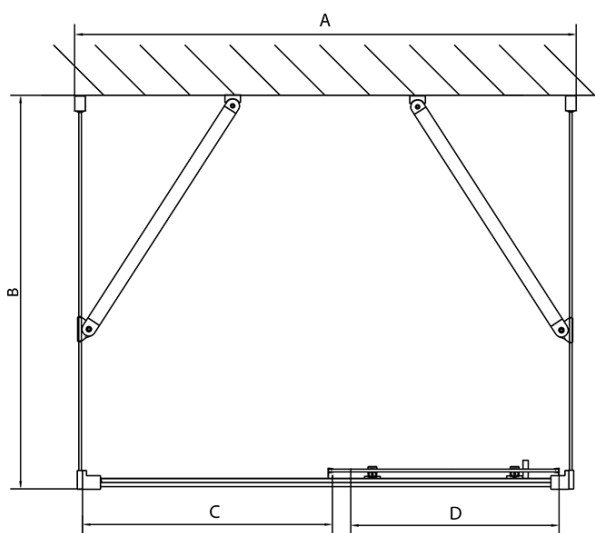

	B
EL3115	680-700
EL3215	780-800
EL3315	880-900
EL3415	980-1000

	A	C	D
EL1015	990-1030	470	400
EL1115	1090-1130	500	430
EL1215	1190-1230	530	480
EL1315	1290-1330	590	530
EL1415	1390-1430	640	580
EL1515	1490-1530	690	630
EL1815	1590-1630	740	680