

**Order code:** FL1115RFL3510

## Basic information

**Brand:** Polysan  
**Series:** FORTIS

## Size

**Width:** 1500 mm  
**Height:** 2000 mm  
**Depth:** 1000 mm

## Properties

**Profile colour:** Chrome - polished aluminum  
**Shape:** Rectangular shower enclosures  
**Type of opening:** Single pivot door  
**Opening direction:** Right  
**Opening width:** 565 mm  
**Glass colour:** TRANSPARENT glass  
**Glass finish:** Antidrop  
**Glass thickness:** 8 mm  
**Properties:** Frameless design  
**Weight / Piece:** 101.0 kg  
**Packaging:** 2 Piece  
**Warranty:** 2 years



Technical sheet



Dveře	A (mm)	B (mm)	C (mm)
FL1080	785-801	≈ 200	779-795
FL1090	885-901	≈ 300	879-895
FL1010	985-1001	≈ 400	979-995
FL1011	1085-1101	≈ 500	1079-1095
FL1012	1185-1201	≈ 600	1179-1195
FL1113	1285-1301	≈ 700	1279-1295
FL1114	1385-1401	≈ 800	1379-1395
FL1115	1485-1501	≈ 900	1479-1495

Boční stěna	E	D
FL3580	785-801	779-795
FL3590	885-901	879-895
FL3510	985-1001	979-995

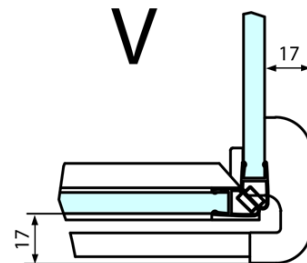
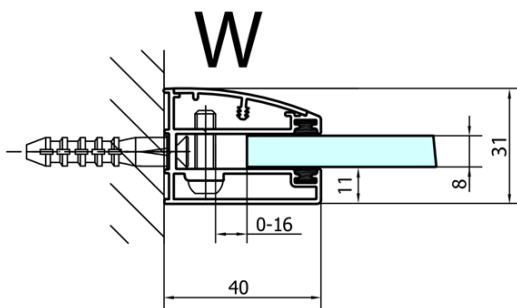
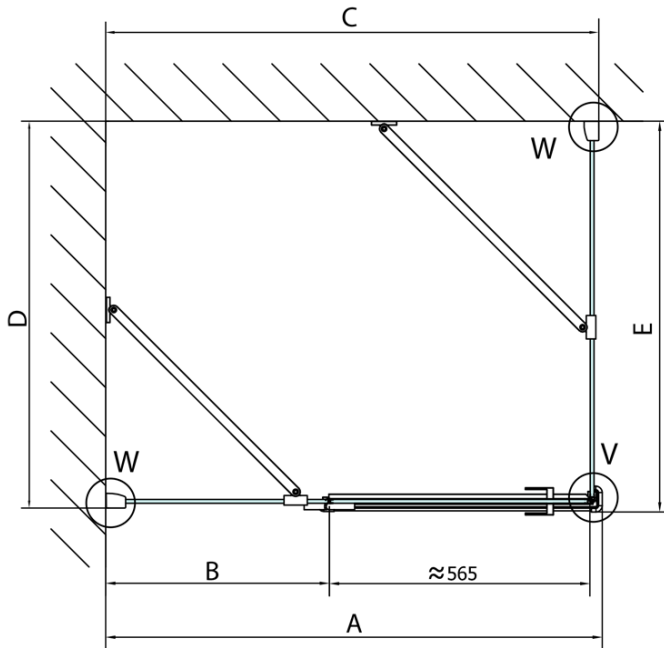

Stavební připravenost pro montáž na dlažbu  
 kóty  $x, y$  = Rozměr k vnitřní straně skla

Construction readiness for floor mounting  
 dimensions  $x, y$  = Dimension to the inside of the glass



Dveře	X (mm)	B (mm)
FL1080	768	≈ 200
FL1090	868	≈ 300
FL1010	968	≈ 400
FL1011	1068	≈ 500
FL1012	1168	≈ 600
FL1113	1268	≈ 700
FL1114	1368	≈ 800
FL1115	1468	≈ 900

Boční stěna	Y
FL3580	768
FL3590	868
FL3510	968
FL3511	1068
FL3512	1168

