

FORTIS Rectangular screen 1400x800 mm, L variant

Order code: FL1114LFL3580

Size

Width: 1400 mm
 Height: 2000 mm
 Depth: 800 mm

Properties

Warranty: 2 years



Technical sheet

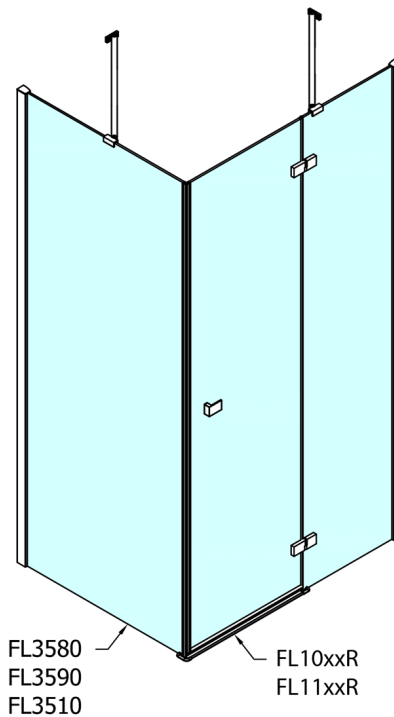
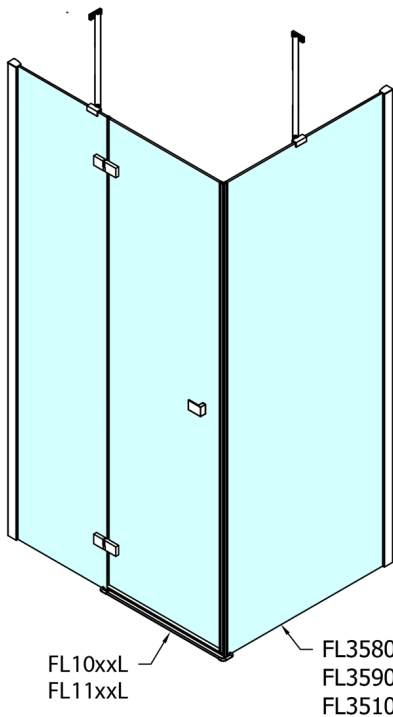

| Dveře | A (mm) | B (mm) | C (mm) |
|--------|-----------|--------|-----------|
| FL1080 | 785-801 | ≈ 200 | 779-795 |
| FL1090 | 885-901 | ≈ 300 | 879-895 |
| FL1010 | 985-1001 | ≈ 400 | 979-995 |
| FL1011 | 1085-1101 | ≈ 500 | 1079-1095 |
| FL1012 | 1185-1201 | ≈ 600 | 1179-1195 |
| FL1113 | 1285-1301 | ≈ 700 | 1279-1295 |
| FL1114 | 1385-1401 | ≈ 800 | 1379-1395 |
| FL1115 | 1485-1501 | ≈ 900 | 1479-1495 |

| Boční stěna | E | D |
|-------------|----------|---------|
| FL3580 | 785-801 | 779-795 |
| FL3590 | 885-901 | 879-895 |
| FL3510 | 985-1001 | 979-995 |

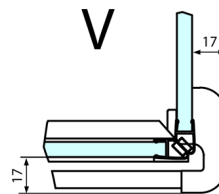
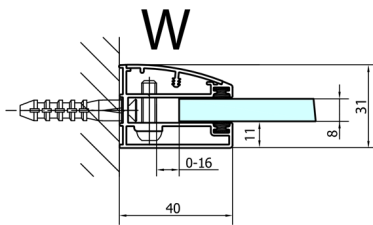
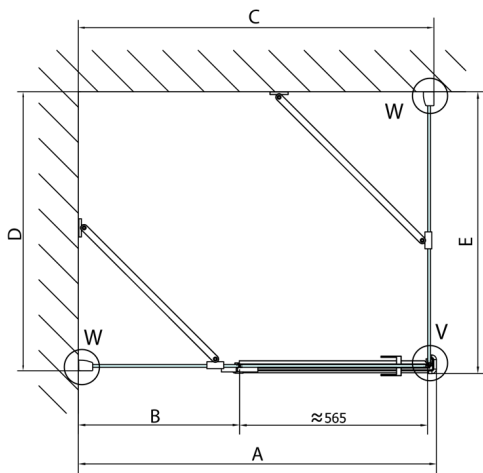

Stavební připravenost pro montáž na dlažbu
 kóty x,y = Rozměr k vnitřní straně skla

Construction readiness for floor mounting
 dimensions x, y = Dimension to the inside of the glass



| Dveře | X (mm) | B (mm) |
|--------|--------|--------|
| FL1080 | 768 | ≈ 200 |
| FL1090 | 868 | ≈ 300 |
| FL1010 | 968 | ≈ 400 |
| FL1011 | 1068 | ≈ 500 |
| FL1012 | 1168 | ≈ 600 |
| FL1113 | 1268 | ≈ 700 |
| FL1114 | 1368 | ≈ 800 |
| FL1115 | 1468 | ≈ 900 |

| Boční stěna | Y |
|-------------|------|
| FL3580 | 768 |
| FL3590 | 868 |
| FL3510 | 968 |
| FL3511 | 1068 |
| FL3512 | 1168 |

