

**Order code:** FL1012LFL1115R

## Basic information

**Brand:** Polysan

**Series:** FORTIS

## Size

**Width:** 1200 mm

**Height:** 2000 mm

**Depth:** 1500 mm

## Properties

**Profile colour:** Chrome - polished aluminum

**Shape:** Rectangular with corner entry

**Type of opening:** Double pivot door

**Opening width:** 795 mm

**Glass colour:** TRANSPARENT glass

**Glass finish:** Antidrop

**Glass thickness:** 8 mm

**Properties:** Frameless design

**Weight / Piece:** 109.0 kg

**Packaging:** 2 Piece

**Warranty:** 2 years



Technical sheet



FL10xxL  
FL11xxL



FL10xxR  
FL11xxR

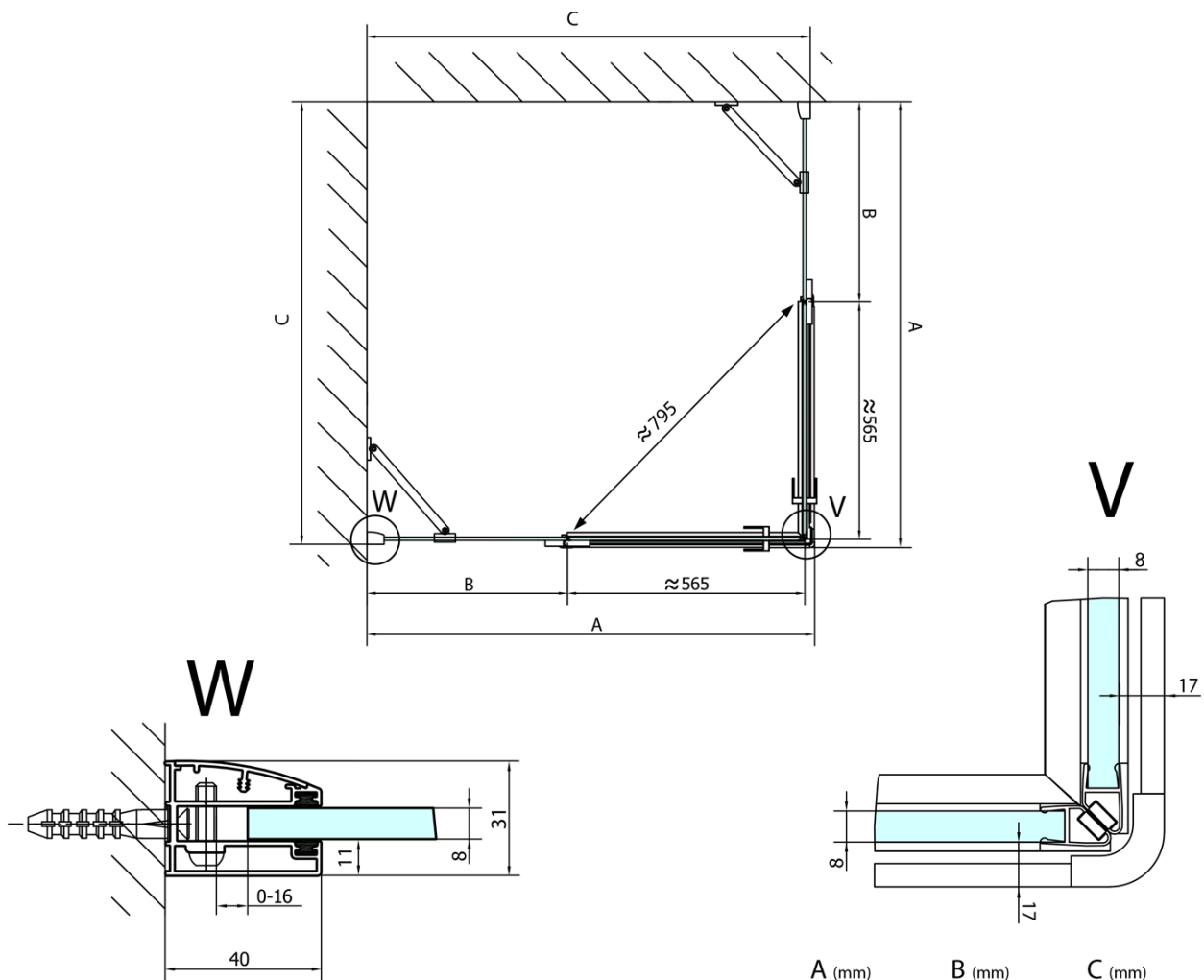

	A (mm)	B (mm)	C (mm)
FL1080	785-801	≈ 210	779-795
FL1090	885-901	≈ 310	879-895
FL1010	985-1001	≈ 410	979-995
FL1011	1085-1101	≈ 510	1079-1095
FL1012	1185-1201	≈ 610	1179-1195
FL1113	1285-1301	≈ 710	1279-1295
FL1114	1385-1401	≈ 810	1379-1395
FL1115	1485-1501	≈ 910	1479-1495