

**Order code:** FL1012LFL1011R

**Basic information**

**Brand:** Polysan  
**Series:** FORTIS

**Size**

**Width:** 1200 mm  
**Height:** 2000 mm  
**Depth:** 1100 mm

**Properties**

**Profile colour:** Chrome - polished aluminum  
**Shape:** Rectangular with corner entry  
**Type of opening:** Double pivot door  
**Opening width:** 795 mm  
**Glass colour:** TRANSPARENT glass  
**Glass finish:** Antidrop  
**Glass thickness:** 8 mm  
**Properties:** Frameless design  
**Weight / Piece:** 100.0 kg  
**Packaging:** 2 Piece  
**Warranty:** 2 years



Technical sheet



FL10xxL  
FL11xxL



FL10xxR  
FL11xxR

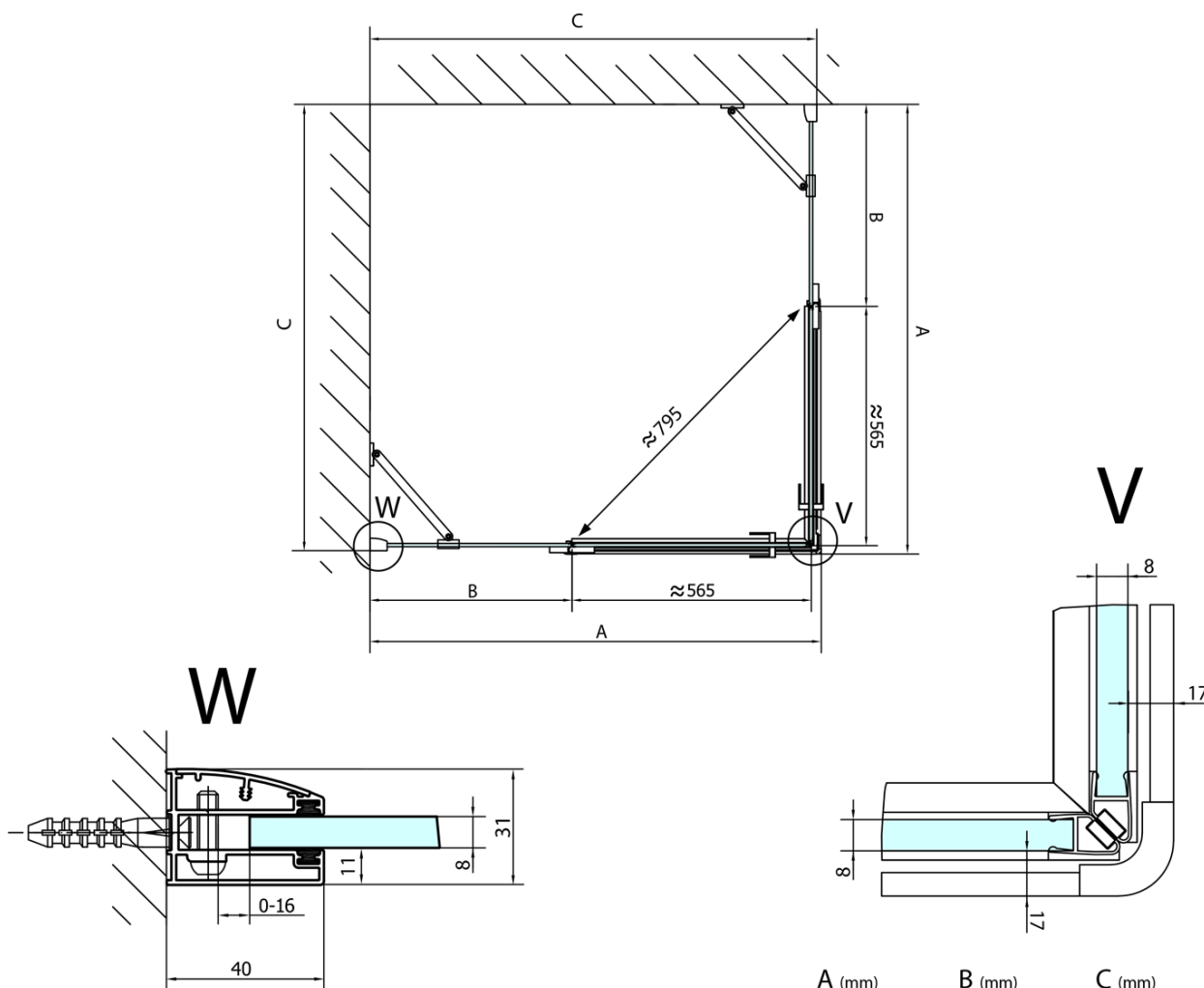

	A (mm)	B (mm)	C (mm)
FL1080	785-801	≈ 210	779-795
FL1090	885-901	≈ 310	879-895
FL1010	985-1001	≈ 410	979-995
FL1011	1085-1101	≈ 510	1079-1095
FL1012	1185-1201	≈ 610	1179-1195
FL1113	1285-1301	≈ 710	1279-1295
FL1114	1385-1401	≈ 810	1379-1395
FL1115	1485-1501	≈ 910	1479-1495