

Order code: FL1012LFL1011R

Basic information

Brand: Polysan

Series: FORTIS

Size

Width: 1200 mm

Height: 2000 mm

Depth: 1100 mm

Properties

Profile colour: Chrome - polished aluminum

Shape: Rectangular with corner entry

Type of opening: Double pivot door

Opening width: 795 mm

Glass colour: TRANSPARENT glass

Glass finish: Antidrop

Glass thickness: 8 mm

Properties: Frameless design

Weight / Piece: 100.0 kg

Packaging: 2 Piece

Warranty: 2 years



Technical sheet



FL10xxL
FL11xxL



FL10xxR
FL11xxR

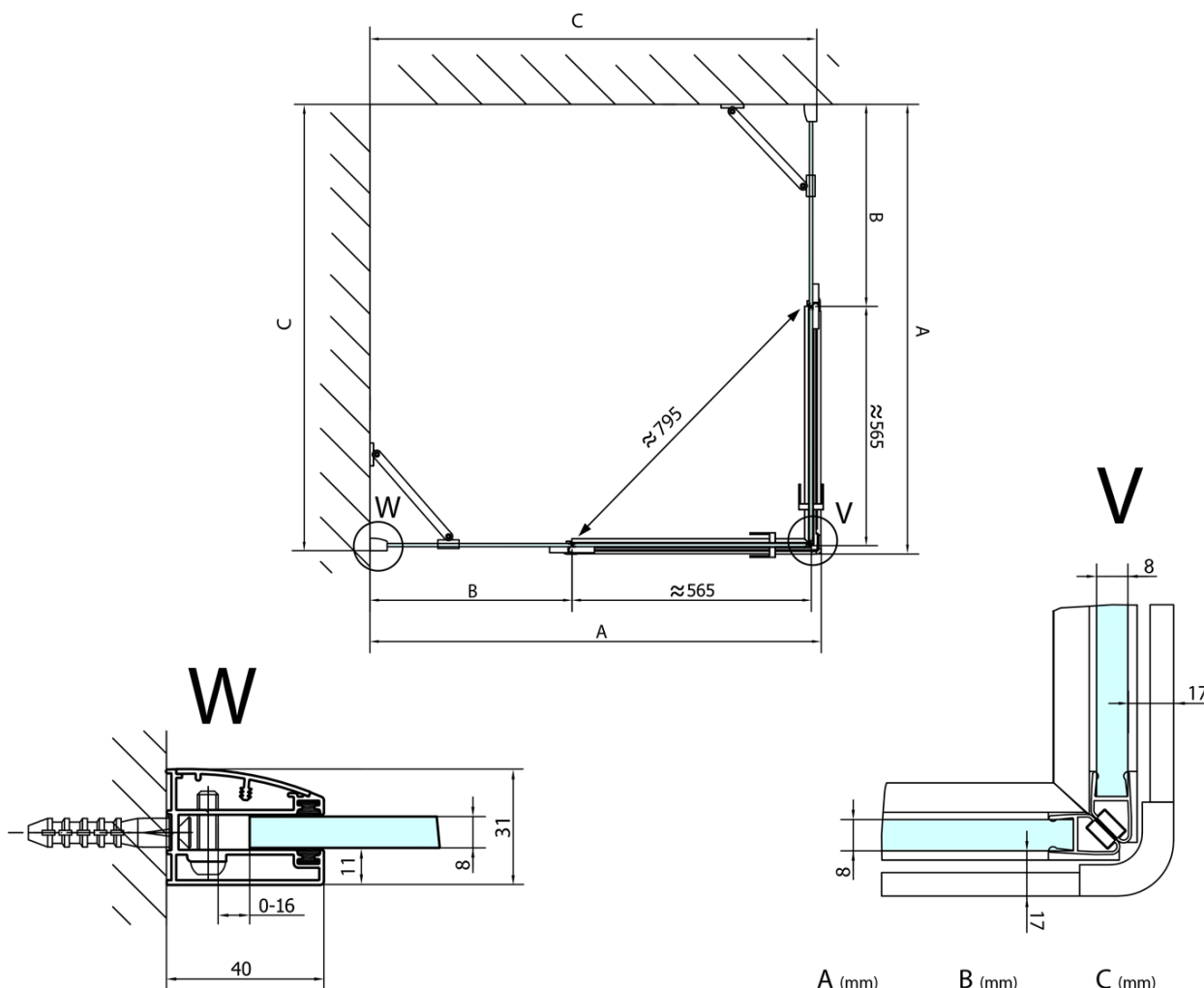

	A (mm)	B (mm)	C (mm)
FL1080	785-801	≈ 210	779-795
FL1090	885-901	≈ 310	879-895
FL1010	985-1001	≈ 410	979-995
FL1011	1085-1101	≈ 510	1079-1095
FL1012	1185-1201	≈ 610	1179-1195
FL1113	1285-1301	≈ 710	1279-1295
FL1114	1385-1401	≈ 810	1379-1395
FL1115	1485-1501	≈ 910	1479-1495