

Order code: FL1010LFL1011R

Basic information

Brand: Polysan
Series: FORTIS

Size

Width: 1000 mm
Height: 2000 mm
Depth: 1100 mm

Properties

Profile colour: Chrome - polished aluminum
Shape: Rectangular with corner entry
Type of opening: Double pivot door
Opening width: 795 mm
Glass colour: TRANSPARENT glass
Glass finish: Antidrop
Glass thickness: 8 mm
Properties: Frameless design
Weight / Piece: 96.0 kg
Packaging: 2 Piece
Warranty: 2 years



Technical sheet



FL10xxL
FL11xxL



FL10xxR
FL11xxR

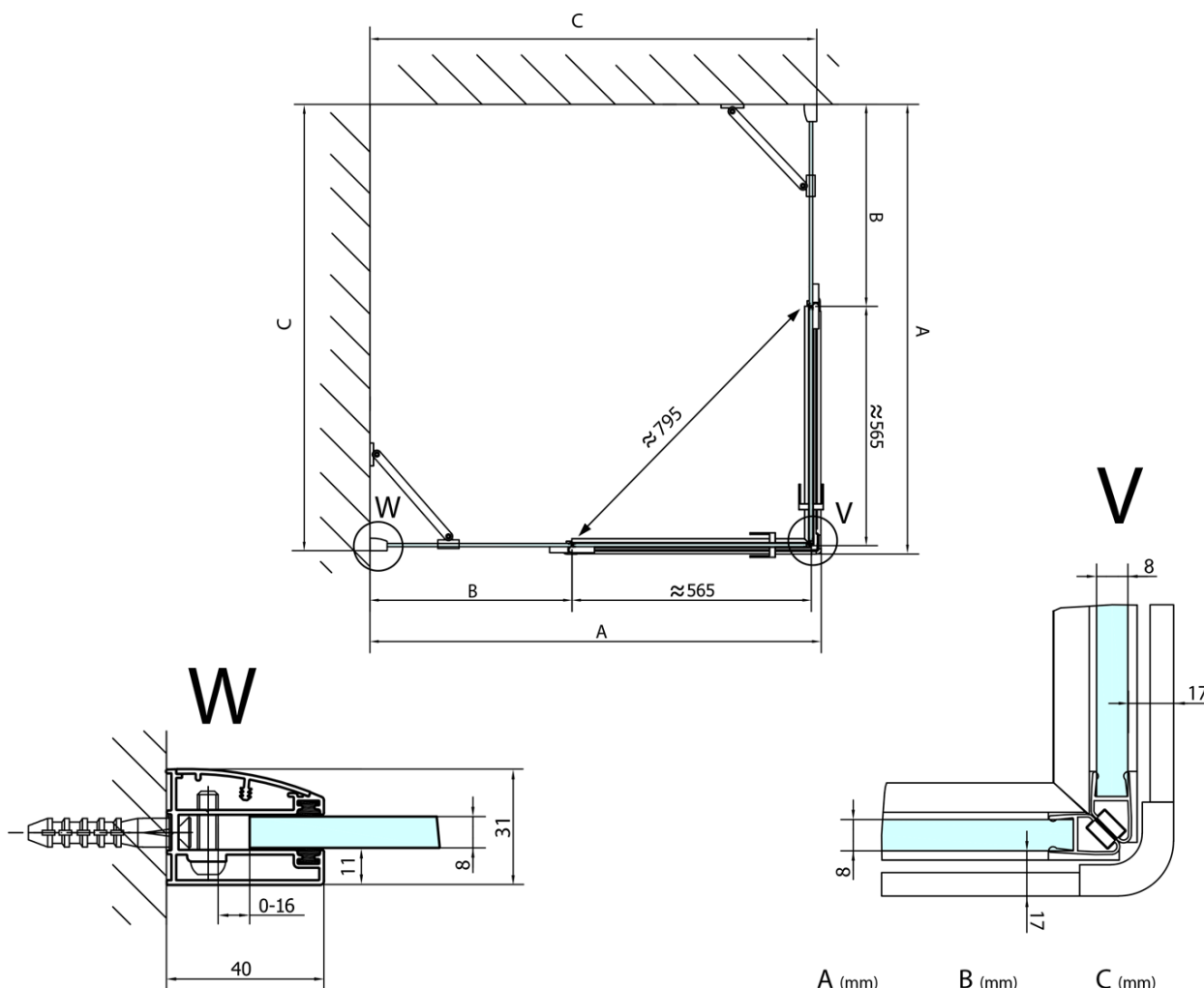

| | A (mm) | B (mm) | C (mm) |
|--------|-----------|--------|-----------|
| FL1080 | 785-801 | ≈ 210 | 779-795 |
| FL1090 | 885-901 | ≈ 310 | 879-895 |
| FL1010 | 985-1001 | ≈ 410 | 979-995 |
| FL1011 | 1085-1101 | ≈ 510 | 1079-1095 |
| FL1012 | 1185-1201 | ≈ 610 | 1179-1195 |
| FL1113 | 1285-1301 | ≈ 710 | 1279-1295 |
| FL1114 | 1385-1401 | ≈ 810 | 1379-1395 |
| FL1115 | 1485-1501 | ≈ 910 | 1479-1495 |