

Order code: FL1114LFL1090R

Basic information

Brand: Polysan
Series: FORTIS

Size

Width: 1400 mm
Height: 2000 mm
Depth: 900 mm

Properties

Profile colour: Chrome - polished aluminum
Shape: Rectangular with corner entry
Type of opening: Double pivot door
Opening width: 795 mm
Glass colour: TRANSPARENT glass
Glass finish: Antidrop
Glass thickness: 8 mm
Properties: Frameless design
Weight / Piece: 97.0 kg
Packaging: 2 Piece
Warranty: 2 years



Technical sheet

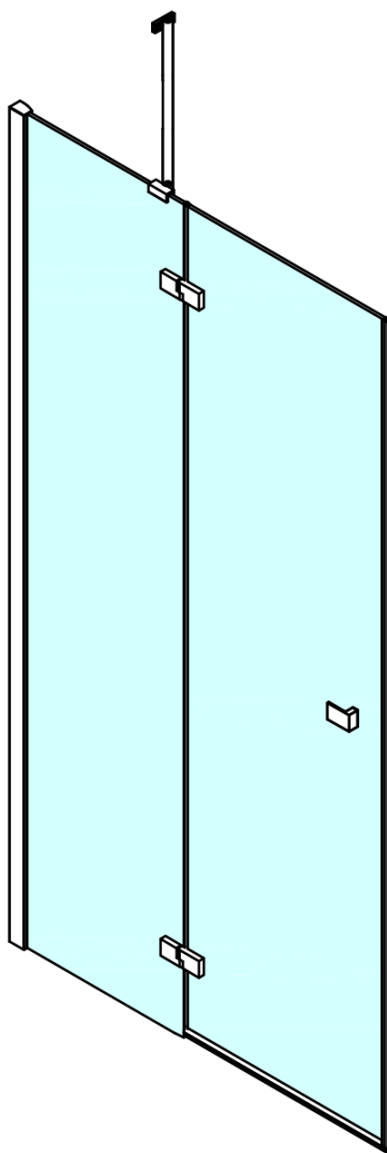

FL10xxL
FL11xxL



FL10xxR
FL11xxR

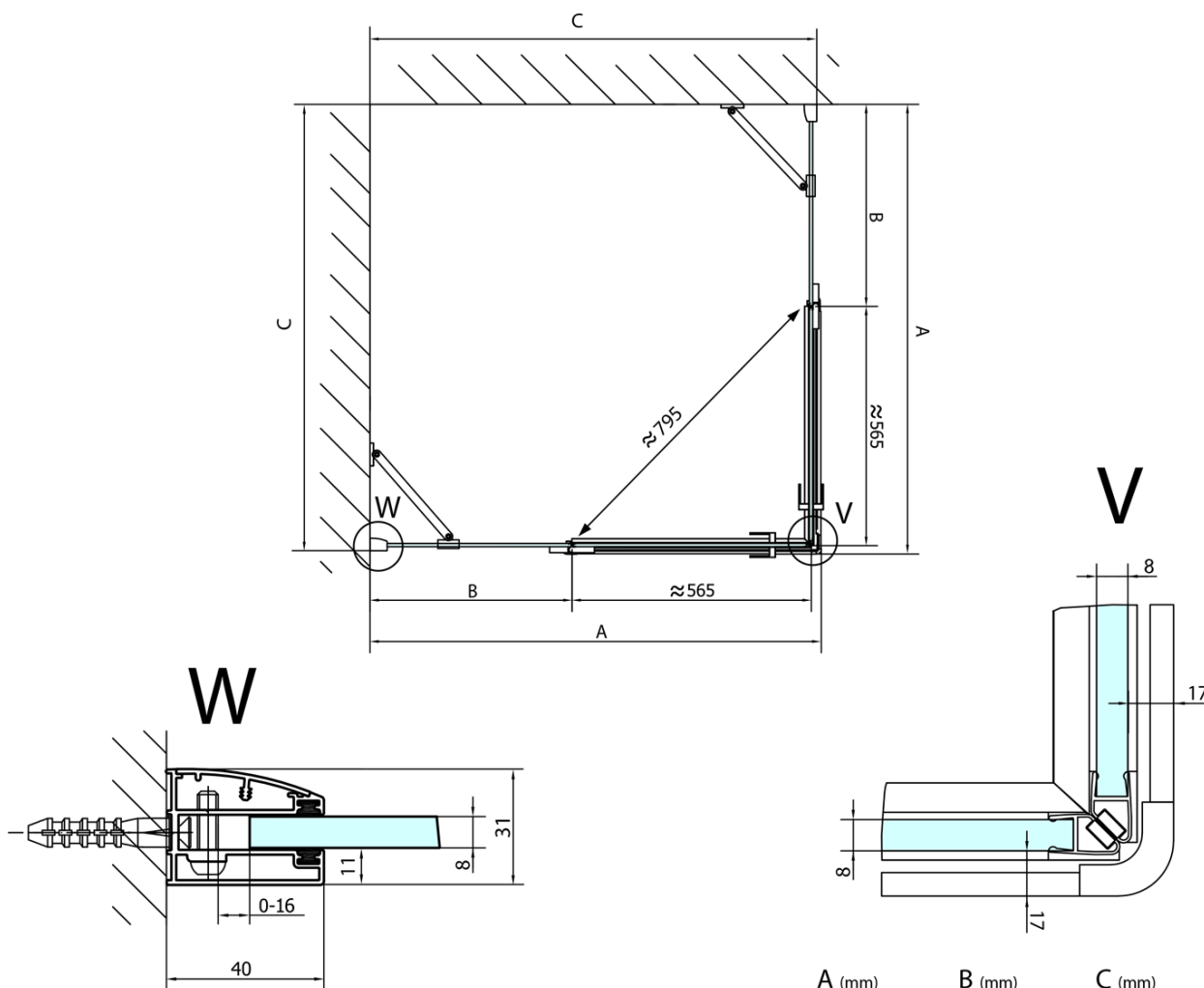

	A (mm)	B (mm)	C (mm)
FL1080	785-801	≈ 210	779-795
FL1090	885-901	≈ 310	879-895
FL1010	985-1001	≈ 410	979-995
FL1011	1085-1101	≈ 510	1079-1095
FL1012	1185-1201	≈ 610	1179-1195
FL1113	1285-1301	≈ 710	1279-1295
FL1114	1385-1401	≈ 810	1379-1395
FL1115	1485-1501	≈ 910	1479-1495