

# FORTIS 3-Piece Alcove Shower Door 1500 mm, clear glass/right



Order code: FL1515R

## Basic information

Brand: Polysan

Series: FORTIS

## Size

Width: 1500 mm

Height: 2000 mm

## Properties

Profile colour: Chrome - polished aluminum

Shape: Alcove door

Type of opening: Single pivot door

Opening direction: Right

Opening width: 565 mm

Glass colour: TRANSPARENT glass

Glass finish: Antidrop

Glass thickness: 8 mm

Installation width from: 1485 mm

Installation width up to: 1517 mm

Properties: Frameless design

Weight / Piece: 58.0 kg

Packaging: 1 Piece

Warranty: 2 years



## Spare parts

Acrylic seal glass/floor (shower tray), length 1000mm for 8mm glass (Order code: 309D-08)

Acrylic gasket between glass 8mm, flag (Order code: NDFL0503)

Technical sheet

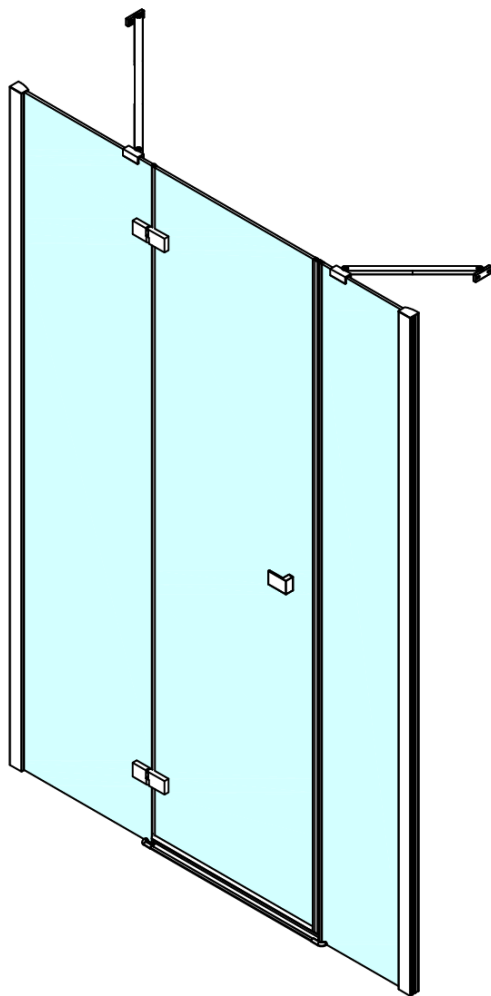

FL15xxL

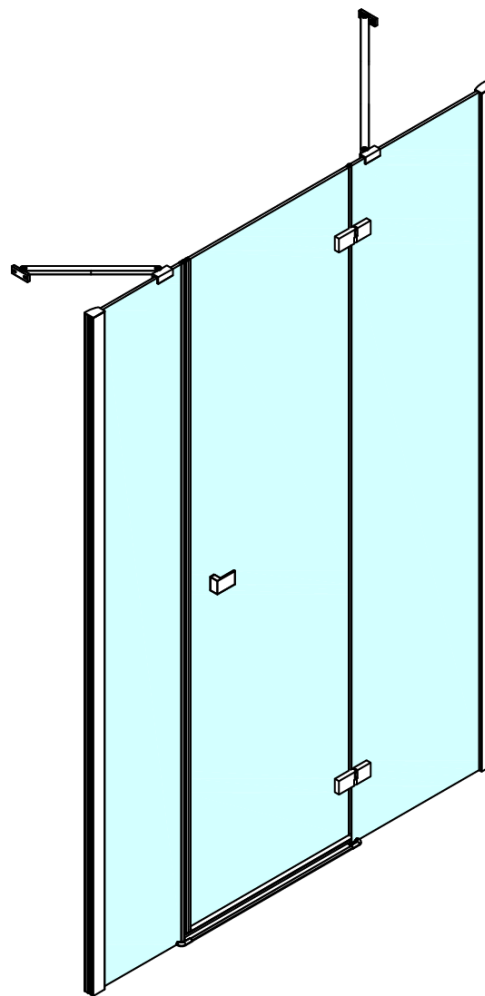

FL15xxR

FORTIS 3-Piece Alcove Shower Door 1500 mm, clear glass/right



MODEL	A	B	C
FL1513	1284-1316	≈361	≈298
FL1514	1384-1416	≈461	≈298
FL1515	1484-1516	≈561	≈298

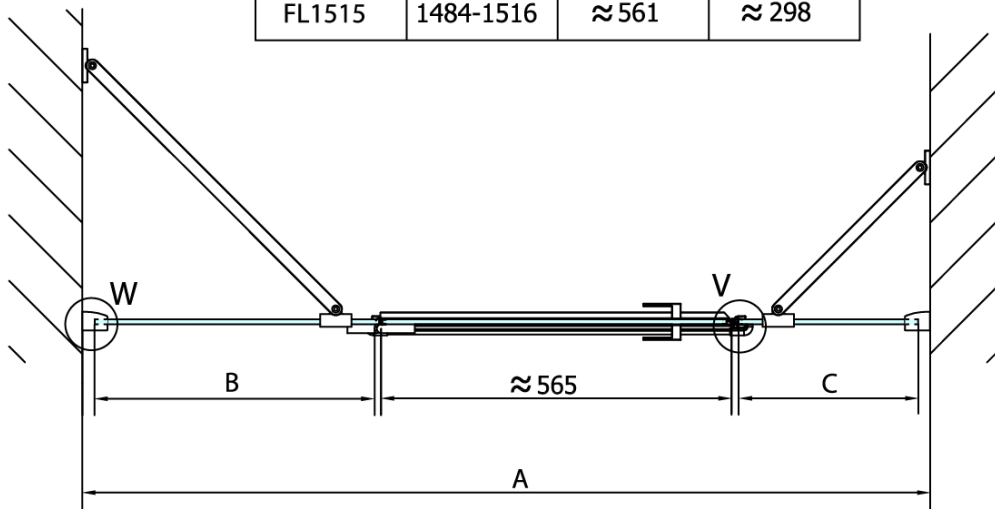

W

V

