

FORTIS 3-Piece Alcove Shower Door 1300 mm, clear glass/left



Order code: FL1513L

Basic information

Brand: Polysan
Series: FORTIS

Size

Width: 1300 mm
Height: 2000 mm

Properties

Profile colour: Chrome - polished aluminum
Shape: Alcove door
Type of opening: Single pivot door
Opening direction: Left
Opening width: 565 mm
Glass colour: TRANSPARENT glass
Glass finish: Antidrop
Glass thickness: 8 mm
Installation width from: 1285 mm
Installation width up to: 1317 mm
Properties: Frameless design
Weight / Piece: 53.0 kg
Packaging: 1 Piece
Warranty: 2 years



Spare parts

Acrylic seal glass/floor (shower tray), length 1000mm for 8mm glass (Order code: 309D-08)
Acrylic gasket between glass 8mm, flag (Order code: NDFL0503)

Technical sheet

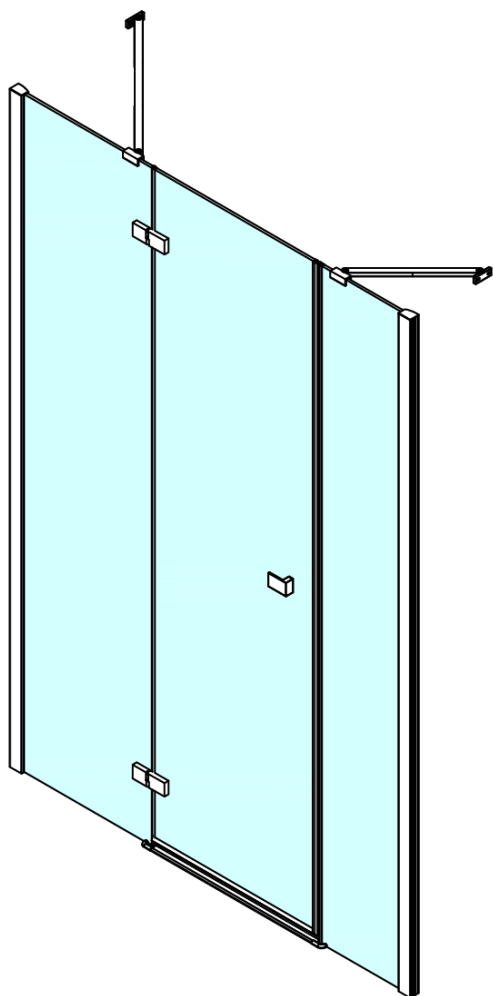

FL15xxL

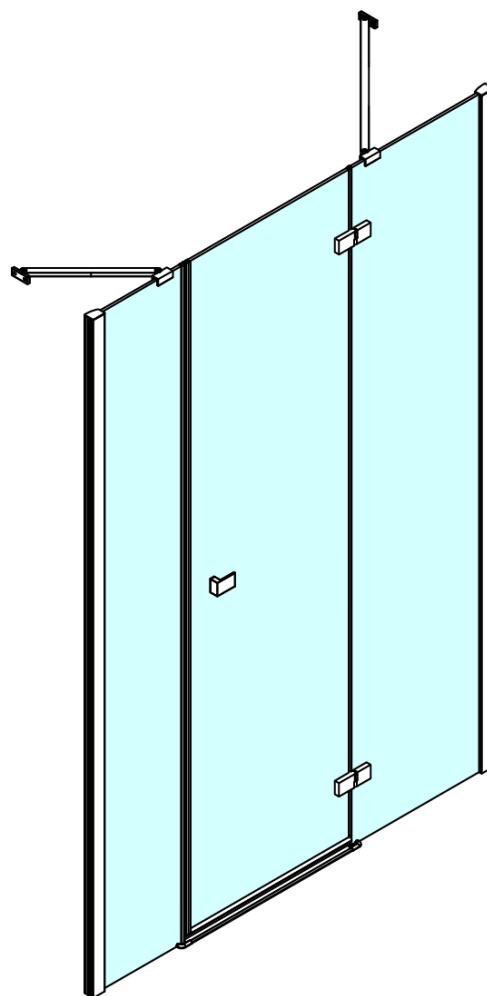

FL15xxR

FORTIS 3-Piece Alcove Shower Door 1300 mm, clear glass/left



MODEL	A	B	C
FL1513	1284-1316	≈361	≈298
FL1514	1384-1416	≈461	≈298
FL1515	1484-1516	≈561	≈298

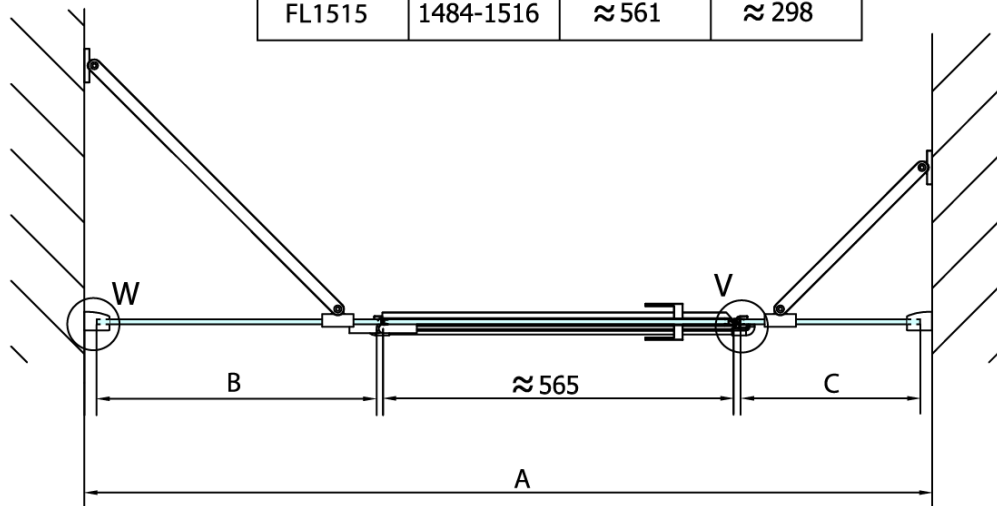

W

V

