

Order code: EL1815

Basic information

Brand: Polysan

Series: EASY

Size

Width: 1600 mm

Height: 1900 mm

Properties

Profile colour: Chrome - polished aluminum

Shape: Alcove door

Type of opening: Sliding door

Opening direction: Versatile

Opening width: 680 mm

Glass colour: TRANSPARENT glass

Glass thickness: 6 mm

Installation width from: 1575 mm

Installation width up to: 1615 mm

Properties: Framed design

Weight / Piece: 48.0 kg

Packaging: 1 Piece

Warranty: 2 years



Spare parts

Set of vertical seals (Order code: NDAE11)

Wall profile (Order code: NDAE12)

Lower tiltable roller (Order code: NDAE33)

AGEL installation kit blister (Order code: NDAESET)

Top covers (Order code: NDAE01LP)

Stop left (Order code: NDAE06L)

Upper roller (Order code: NDAE32)

Stop right (Order code: NDAE06P)

Set of crimp seals (Order code: NDAE14)

Technical sheet

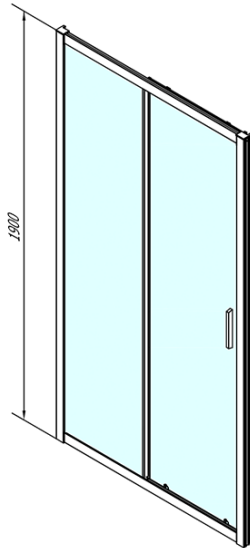

EL1815L

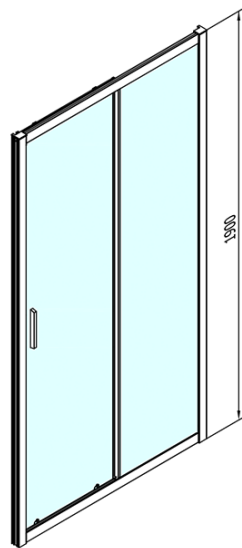

EL1815R

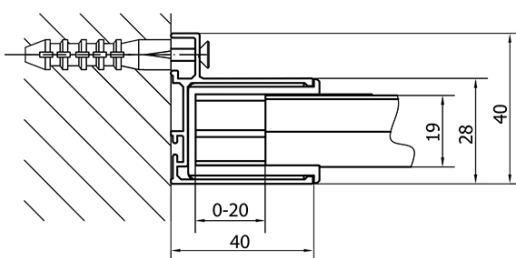
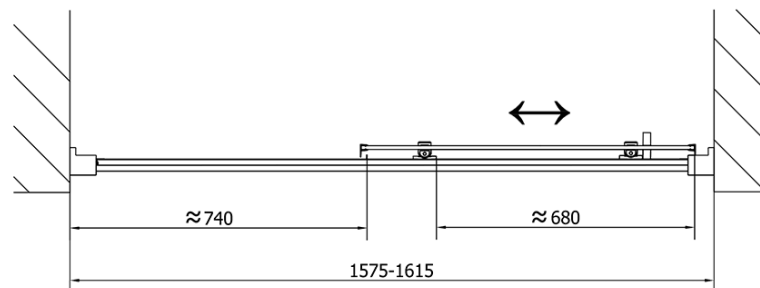

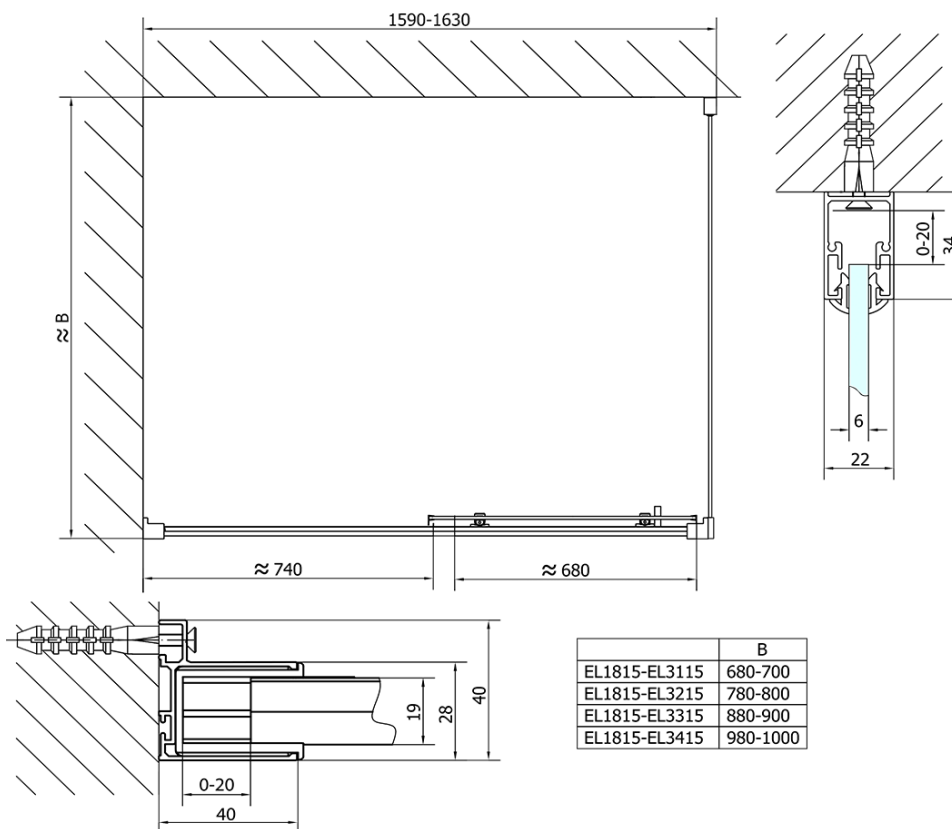
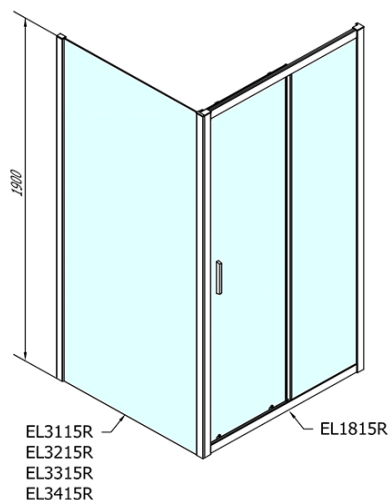
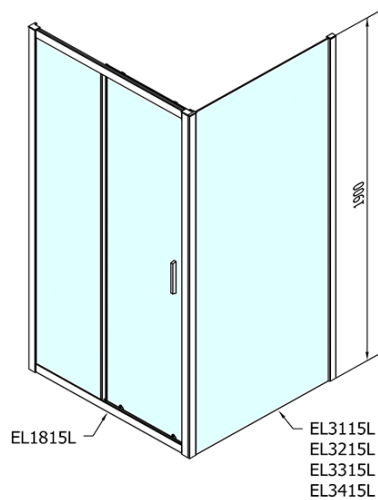

	B
EL1815-EL3115	680-700
EL1815-EL3215	780-800
EL1815-EL3315	880-900
EL1815-EL3415	980-1000