

LUCIS LINE quadrant shower enclosure 1000x800mm, left/right



Order code: DL4815

Basic information

Brand: Polysan
Series: LUCIS LINE

Size

Width: 1000 mm
Height: 2000 mm
Depth: 800 mm

Properties

Profile colour: Chrome - polished aluminum
Shape: Quadrant with extended side panel
Type of opening: Sliding door
Opening width: 460 mm
Glass colour: TRANSPARENT glass
Glass finish: Antidrop
Glass thickness: 6 mm
Radius: R550
Properties: Framed design
Weight / Piece: 54.0 kg
Packaging: 1 Piece
Warranty: 2 years



LUCIS LINE quadrant shower enclosure
1000x800mm, left/right

Technical sheet

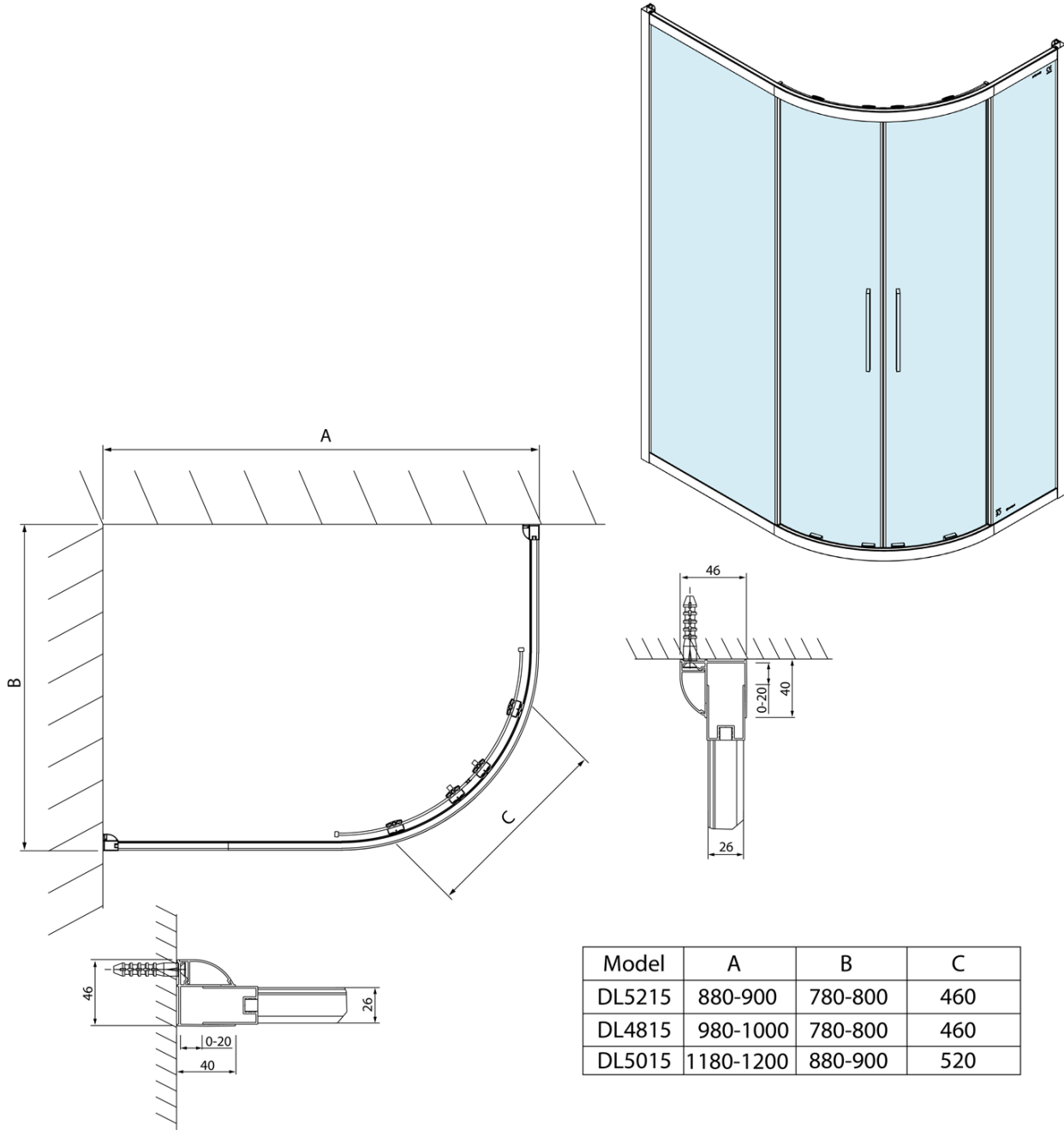

Model	A	B	C
DL5215	880-900	780-800	460
DL4815	980-1000	780-800	460
DL5015	1180-1200	880-900	520