

LUCIS LINE Rectangular screen 1300x900mm L/R variant

Order code: DL1315DL3415

Size

Width: 1300 mm
 Height: 2000 mm
 Depth: 900 mm

Properties

Warranty: 2 years



Technical sheet

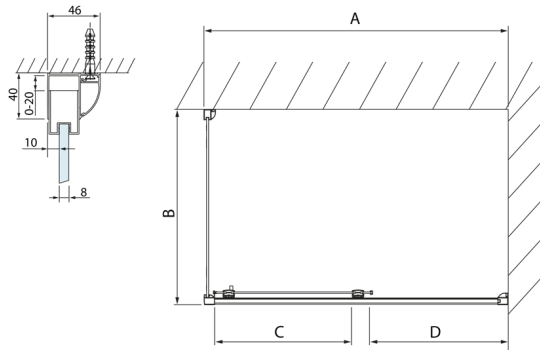
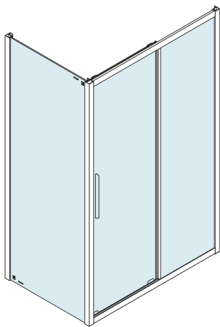

Model	A	C	D
DL1015	970-1010	375	~437
DL1115	1070-1110	425	~487
DL1215	1170-1210	475	~537
DL1315	1270-1310	525	~587
DL1415	1370-1410	575	~637

Model	B
DL3215	670-690
DL3315	770-790
DL3415	870-890
DL3515	970-990

