

**Order code:** DL3315

**Basic information**

**Brand:** Polysan  
**Series:** LUCIS LINE

**Size**

**Height:** 2000 mm  
**Depth:** 800 mm

**Properties**

**Profile colour:** Chrome - polished aluminum  
**Shape:** Fixed panel for shower door  
**Glass colour:** TRANSPARENT glass  
**Glass finish:** Antidrop  
**Glass thickness:** 8 mm  
**Weight / Piece:** 29.01 kg  
**Packaging:** 1 Piece  
**Warranty:** 2 years



Technical sheet

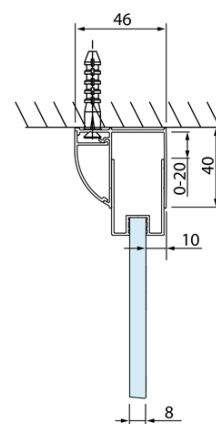
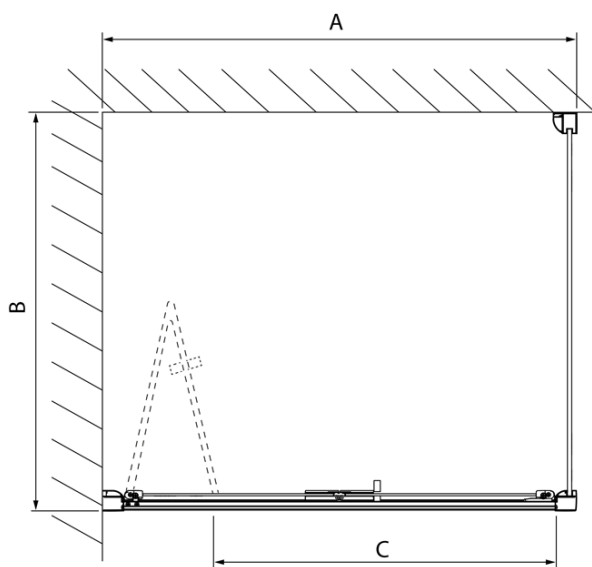
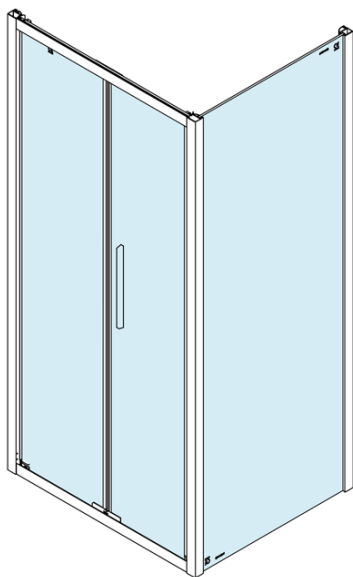

Model	A	C
DL2715	770-810	575
DL2815	870-910	675

Model	B
DL3215	670-690
DL3315	770-790
DL3415	870-890
DL3515	970-990

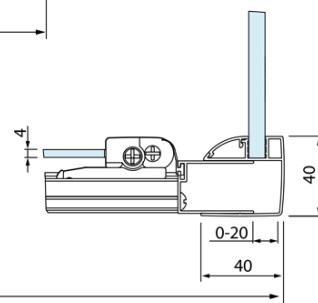
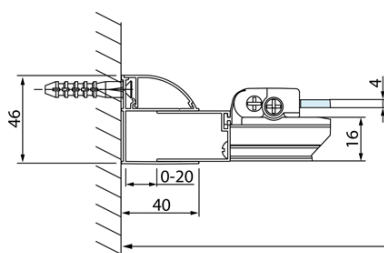

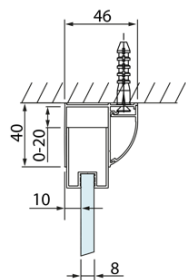

Model	A	C	D
DL1015	970-1010	375	~437
DL1115	1070-1110	425	~487
DL1215	1170-1210	475	~537
DL1315	1270-1310	525	~587
DL1415	1370-1410	575	~637

Model	B
DL3215	670-690
DL3315	770-790
DL3415	870-890
DL3515	970-990



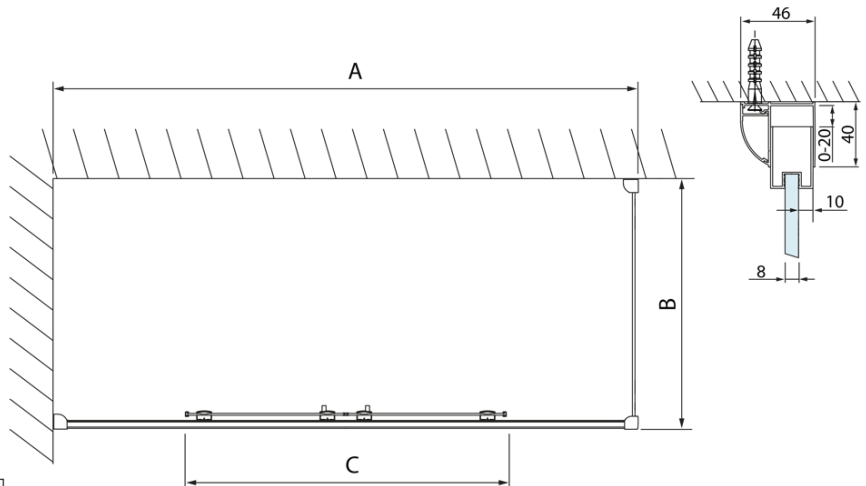
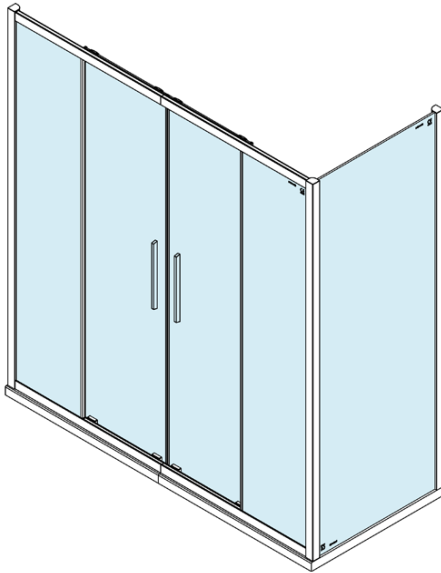

Model	A	C
DL4215	1470-1510	560
DL4315	1570-1610	610

Model	B
DL3215	670-690
DL3315	770-790
DL3415	870-890
DL3515	970-990

