

Order code: FB900

Basic information

Brand: Polysan

Size

Width: 900 mm

Height: 1500 mm

Properties

Profile colour: Black matt

Type of opening: Pivot door folding

Glass colour: TRANSPARENT glass

Glass finish: Antidrop

Glass thickness: 6 mm

Weight / Piece: 21.5 kg

Packaging: 1 Piece

Warranty: 2 years



Technical sheet

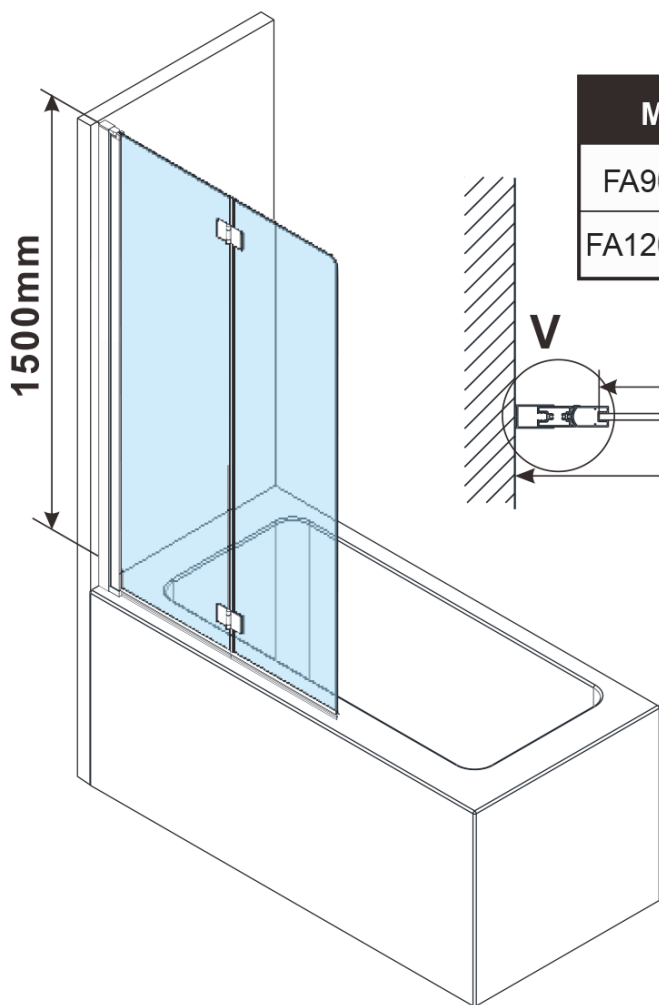

MODEL	A,mm	B1/B2,mm	C,mm
FA900/FB900	885~900	418/395	455
FA1200/FB1200	1185~1200	568/545	605

