

# EB500

## ELECTRIC TOWEL HEATER INSTALLATION MANUAL



### PRODUCT INFORMATION

Size	500x475x220MM
Voltage	220-240V
Power	60W
Frequency	50-60Hz
N.W	2. 6 kg
Color	Matt White
Cord lenght	1.5m
Water-proof grade	IPX4
IEC protection class	I.
Material	304 stainless steel

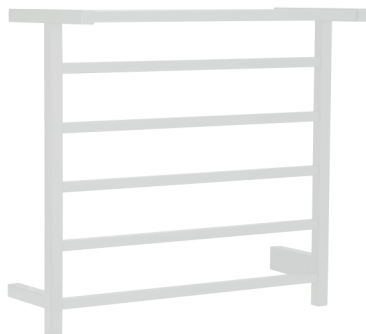

### DIMENSIONS Unit:mm

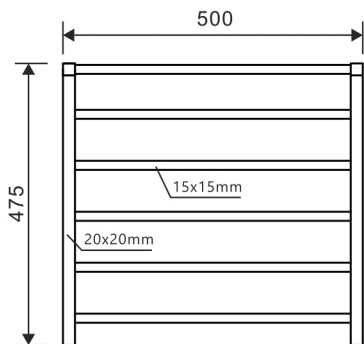

Front view

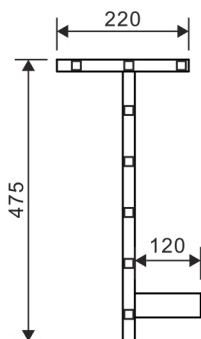

Side view

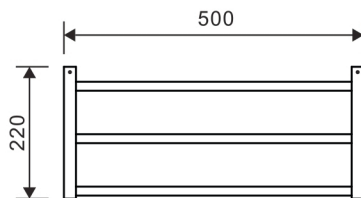

Top view

\* Stated dimensions may vary. Never drill holes in the wall without first checking the dimensions of your actual towel warmer.

# EB500

## ELECTRIC TOWEL HEATER INSTALLATION MANUAL





### Please read through these instructions before installation

#### WARNING

1. Never use cleaners containing abrasive cleansers, ammonia, bleach, acids, waxes, or solvents for cleaning as they may damage the finish. Do not allow any liquid into the products. Do not wash the product directly with water. Do not allow any liquid into the product.
2. The single bar of the product can bear 10kgs, and do not hang overweight items.
3. Please do not disassemble or modify the product by yourself. Do not attempt to repair this product as it may cause accidental injury.
4. If the product is abnormal and cannot be used normally, please immediately cut off the power supply and contact the after-sales staff for inspection and maintenance.
5. Make sure the power to the unit is off, and the power cord is unplugged from the wall outlet before proceeding with installation.
6. The product must be installed by a qualified electrician.

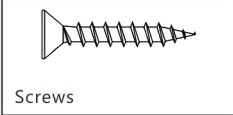
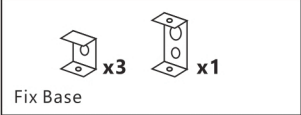
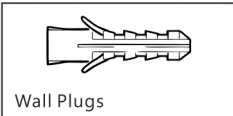
#### PRODUCT ACCESSORIES LIST

- |  |   |   |
|--|---|---|
| <b>1</b><br> | <b>2</b><br><br>Screws     | <b>4</b><br><br>Fix Base      |
|  | <b>3</b><br><br>Wall Plugs | <b>5</b><br><br>Fixing Screws  |
|  |   | <b>6</b><br><br>Plastic Cover |

## FOR EXPOSED

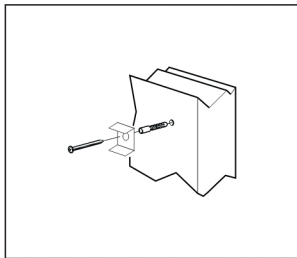

### STEP1

Locate and mark

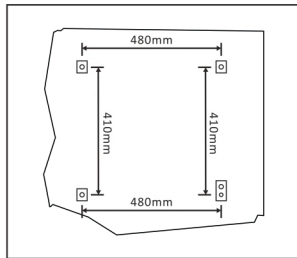

### STEP2

Screw and fix the base

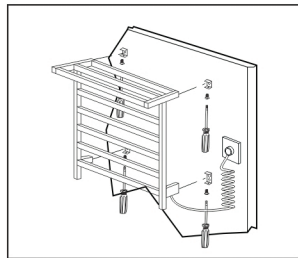

### STEP3

Hung up and fix

## FOR CONCEALED

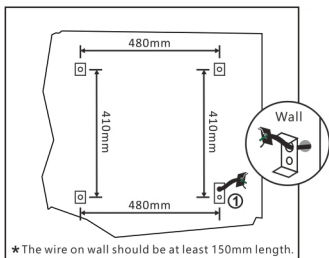

### STEP1

put the wire through the base ① and fix the base. Then fix the rest 3 base accordingly.

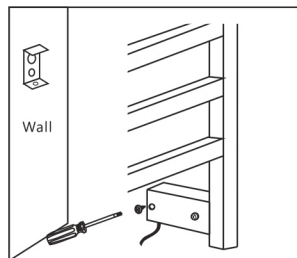

### STEP2

Open the installation feet

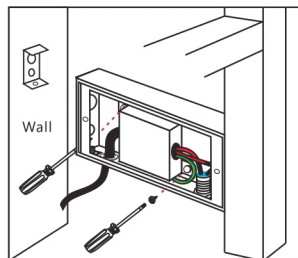

### STEP3

Unscrew the wire box

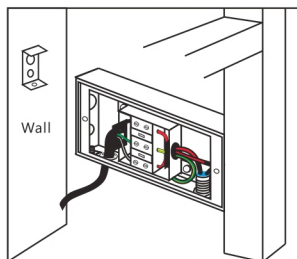

### STEP4

Open the wire box

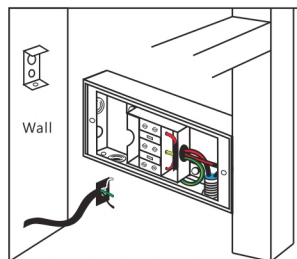

### STEP5

Loosen the screw and unplug the exposed cable

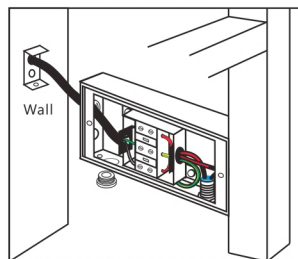

### STEP6

Hung up and put the wire from wall into the installation feet

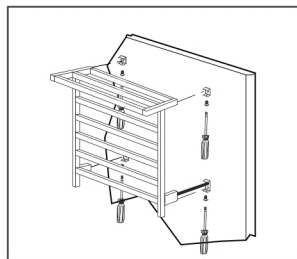

### STEP7

Fix on the wall

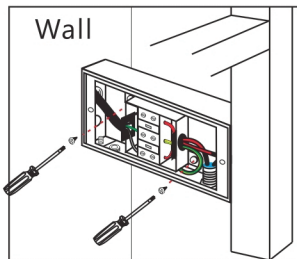

### STEP8

Screw and fix the wire box

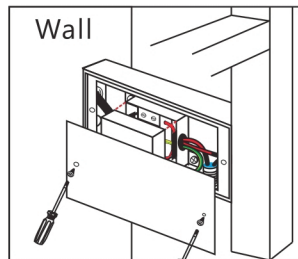

### STEP9

Close the box and screw