

ESCA CHROME Dusch-Glasteil, Wandmontage, graues matt Glas, 800 mm

Bestellcode: ES1480-01

Größe

Höhe: 2100 mm

Tiefe: 800 mm

Eigenschaften

Garantie: 2 Jahre



Technisches Arbeitsblatt

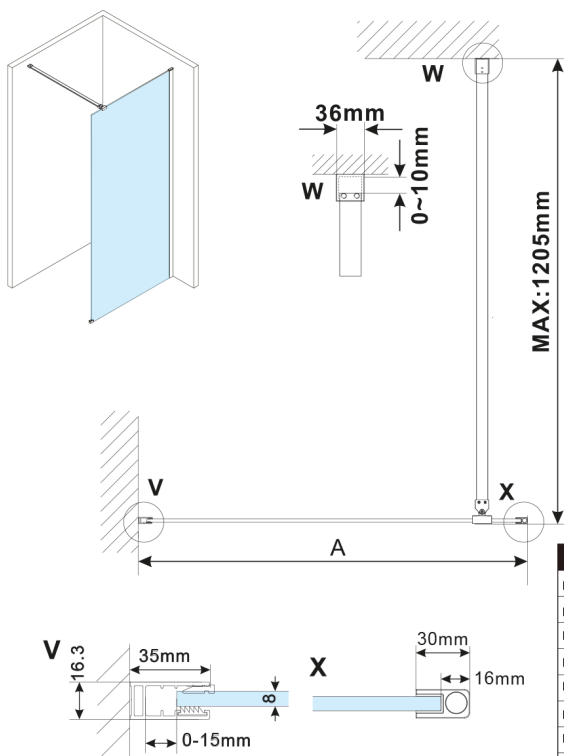

MODEL	A,mm
ES1070, ES1170, ES1270, ES1370, ES1470, ES1570	690-705
ES1080, ES1180, ES1280, ES1380, ES1480, ES1580	790-805
ES1090, ES1190, ES1290, ES1390, ES1490, ES1590	890-905
ES1010, ES1110, ES1210, ES1310, ES1410, ES1510	990-1005
ES1011, ES1111, ES1211, ES1311, ES1411, ES1511	1090-1105
ES1012, ES1112, ES1212, ES1312, ES1412, ES1512	1190-1205
ES1013, ES1113, ES1213, ES1313, ES1413, ES1513	1290-1305
ES1014, ES1114, ES1214, ES1314, ES1414, ES1514	1390-1405
ES1015, ES1115, ES1215, ES1315, ES1415, ES1515	1490-1505

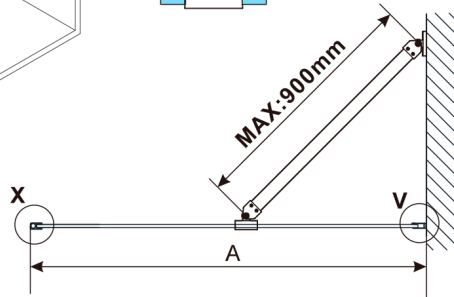
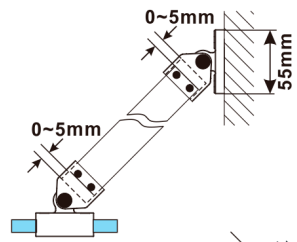
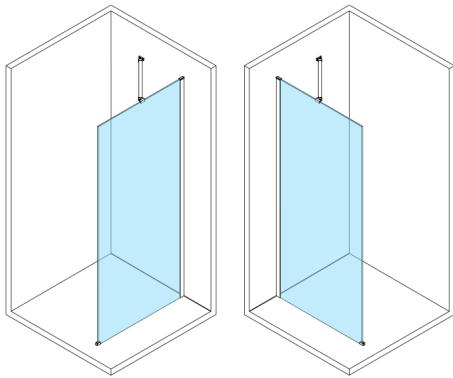

MODEL	A,mm
ES1070, ES1170, ES1270, ES1370, ES1470, ES1570	690-705
ES1080, ES1180, ES1280, ES1380, ES1480, ES1580	790-805
ES1090, ES1190, ES1290, ES1390, ES1490, ES1590	890-905
ES1010, ES1110, ES1210, ES1310, ES1410, ES1510	990-1005
ES1011, ES1111, ES1211, ES1311, ES1411, ES1511	1090-1105
ES1012, ES1112, ES1212, ES1312, ES1412, ES1512	1190-1205
ES1013, ES1113, ES1213, ES1313, ES1413, ES1513	1290-1305
ES1014, ES1114, ES1214, ES1314, ES1414, ES1514	1390-1405
ES1015, ES1115, ES1215, ES1315, ES1415, ES1515	1490-1505

