

## ESCA Klarglas 467x2100mm

Bestellcode: ES1050

### Eigenschaften

Garantie: 3 Jahre



## Technisches Arbeitsblatt

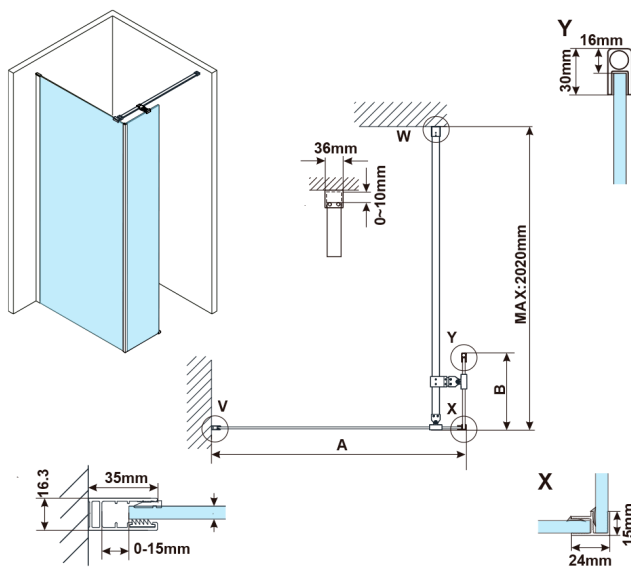

MODEL	A,mm
ES1070	686~701
ES1080	786~801
ES1090	886~901
ES1010	986~1001
ES1011	1086~1101
ES1012	1186~1201
ES1013	1286~1301
ES1014	1386~1401
ES1015	1486~1501

MODEL	B,mm
ES1030	285
ES1040	385
ES1050	485
ES1060	585

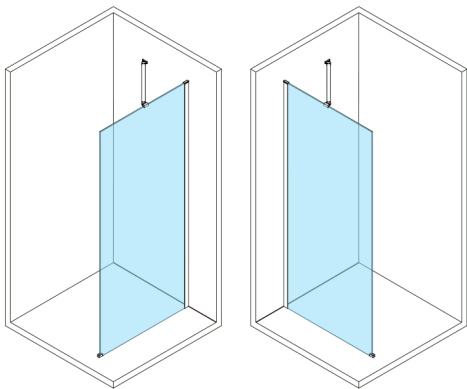

MODEL	A,mm
ES1030	290-305
ES1040	390-405
ES1050	490-505
ES1060	590-605

MODEL	A,mm
ES1070, ES1170, ES1270, ES1370, ES1470, ES1570	690-705
ES1080, ES1180, ES1280, ES1380, ES1480, ES1580	790-805
ES1090, ES1190, ES1290, ES1390, ES1490, ES1590	890-905
ES1010, ES1110, ES1210, ES1310, ES1410, ES1510	990-1005
ES1011, ES1111, ES1211, ES1311, ES1411, ES1511	1090-1105
ES1012, ES1112, ES1212, ES1312, ES1412, ES1512	1190-1205
ES1013, ES1113, ES1213, ES1313, ES1413, ES1513	1290-1305
ES1014, ES1114, ES1214, ES1314, ES1414, ES1514	1390-1405
ES1015, ES1115, ES1215, ES1315, ES1415, ES1515	1490-1505

