

ESCA graues matt Glas 867x2100mm

Bestellcode: ES1490

Größe

Breite: 867 mm

Höhe: 2100 mm

Eigenschaften

Garantie: 3 Jahre

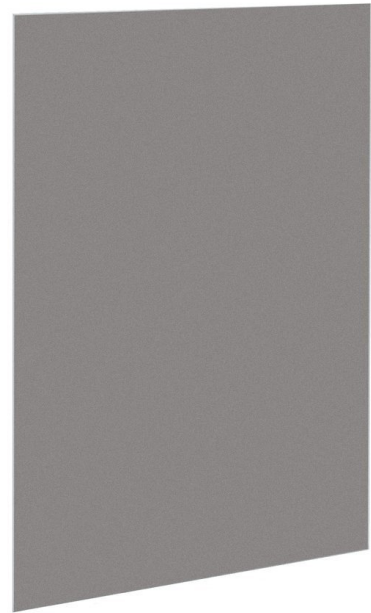

Technisches Arbeitsblatt

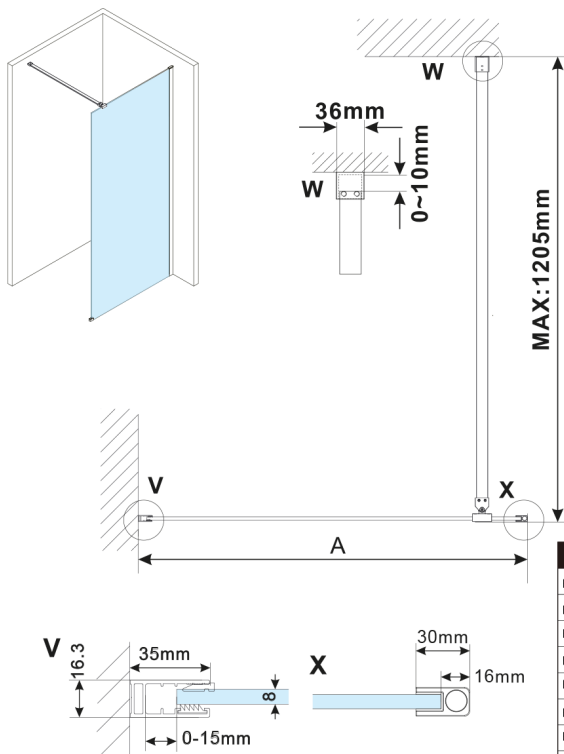

MODEL	A,mm
ES1070,ES1170,ES1270,ES1370,ES1470,ES1570	690-705
ES1080,ES1180,ES1280,ES1380,ES1480,ES1580	790-805
ES1090,ES1190,ES1290,ES1390,ES1490,ES1590	890-905
ES1010,ES1110,ES1210,ES1310,ES1410,ES1510	990-1005
ES1011,ES1111,ES1211,ES1311,ES1411,ES1511	1090-1105
ES1012,ES1112,ES1212,ES1312,ES1412,ES1512	1190-1205
ES1013,ES1113,ES1213,ES1313,ES1413,ES1513	1290-1305
ES1014,ES1114,ES1214,ES1314,ES1414,ES1514	1390-1405
ES1015,ES1115,ES1215,ES1315,ES1415,ES1515	1490-1505

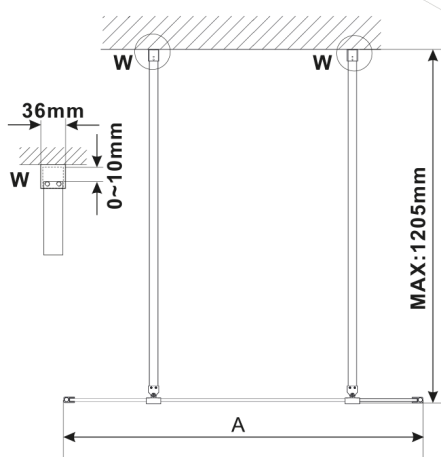
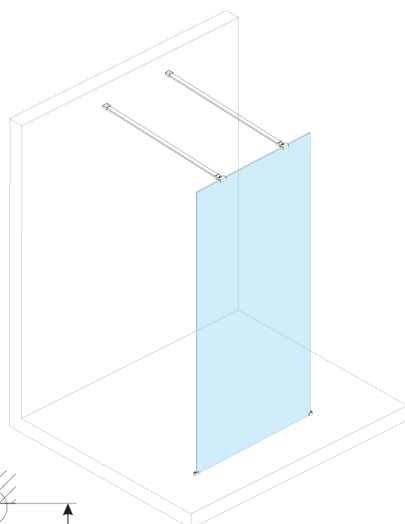

MODEL	A,mm
ES1070,ES1170,ES1270,ES1370,ES1470,ES1570	699
ES1080,ES1180,ES1280,ES1380,ES1480,ES1580	799
ES1090,ES1190,ES1290,ES1390,ES1490,ES1590	899
ES1010,ES1110,ES1210,ES1310,ES1410,ES1510	999
ES1011,ES1111,ES1211,ES1311,ES1411,ES1511	1099
ES1012,ES1112,ES1212,ES1312,ES1412,ES1512	1199
ES1013,ES1113,ES1213,ES1313,ES1413,ES1513	1299
ES1014,ES1114,ES1214,ES1314,ES1414,ES1514	1399
ES1015,ES1115,ES1215,ES1315,ES1415,ES1515	1499

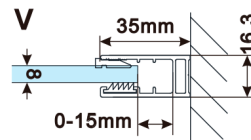
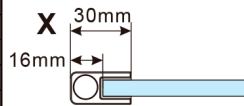
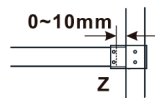
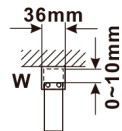
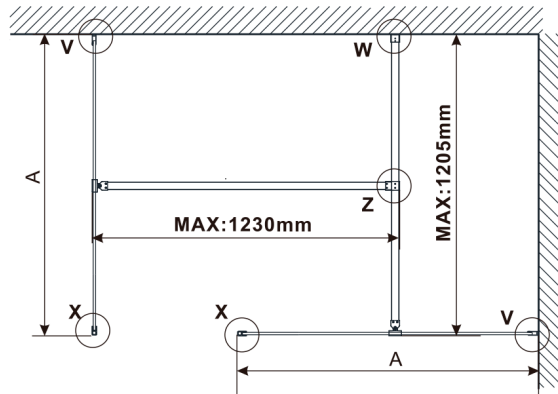
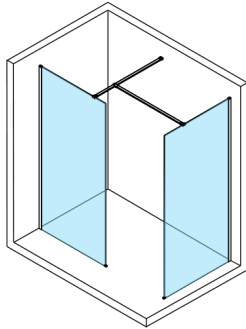
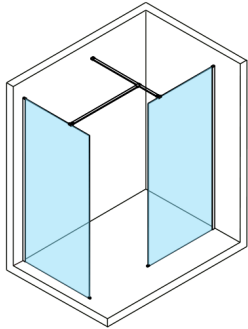

MODEL	A,mm
ES1070/ES1170/ES1270/ES1370/ES1470/ES1570	690-705
ES1080/ES1180/ES1280/ES1380/ES1480/ES1580	790-805
ES1090/ES1190/ES1290/ES1390/ES1490/ES1590	890-905
ES1010/ES1110/ES1210/ES1310/ES1410/ES1510	990-1005
ES1011/ES1111/ES1211/ES1311/ES1411/ES1511	1090-1105
ES1012/ES1112/ES1212/ES1312/ES1412/ES1512	1190-1205
ES1013/ES1113/ES1213/ES1313/ES1413/ES1513	1290-1305
ES1014/ES1114/ES1214/ES1314/ES1414/ES1514	1390-1405
ES1015/ES1115/ES1215/ES1315/ES1415/ES1515	1490-1505

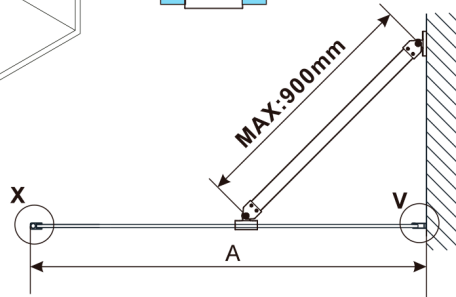
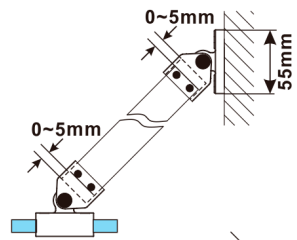
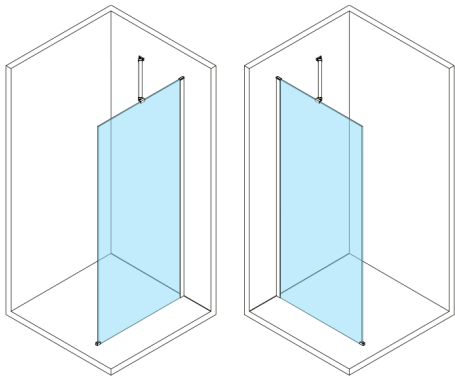

MODEL	A,mm
ES1070, ES1170, ES1270, ES1370, ES1470, ES1570	690-705
ES1080, ES1180, ES1280, ES1380, ES1480, ES1580	790-805
ES1090, ES1190, ES1290, ES1390, ES1490, ES1590	890-905
ES1010, ES1110, ES1210, ES1310, ES1410, ES1510	990-1005
ES1011, ES1111, ES1211, ES1311, ES1411, ES1511	1090-1105
ES1012, ES1112, ES1212, ES1312, ES1412, ES1512	1190-1205
ES1013, ES1113, ES1213, ES1313, ES1413, ES1513	1290-1305
ES1014, ES1114, ES1214, ES1314, ES1414, ES1514	1390-1405
ES1015, ES1115, ES1215, ES1315, ES1415, ES1515	1490-1505

