

**Bestellcode:** ZL4815BL

**Größe**

Breite: 800 mm  
Höhe: 2000 mm

**Eigenschaften**

Garantie: 3 Jahre



## Technisches Arbeitsblatt

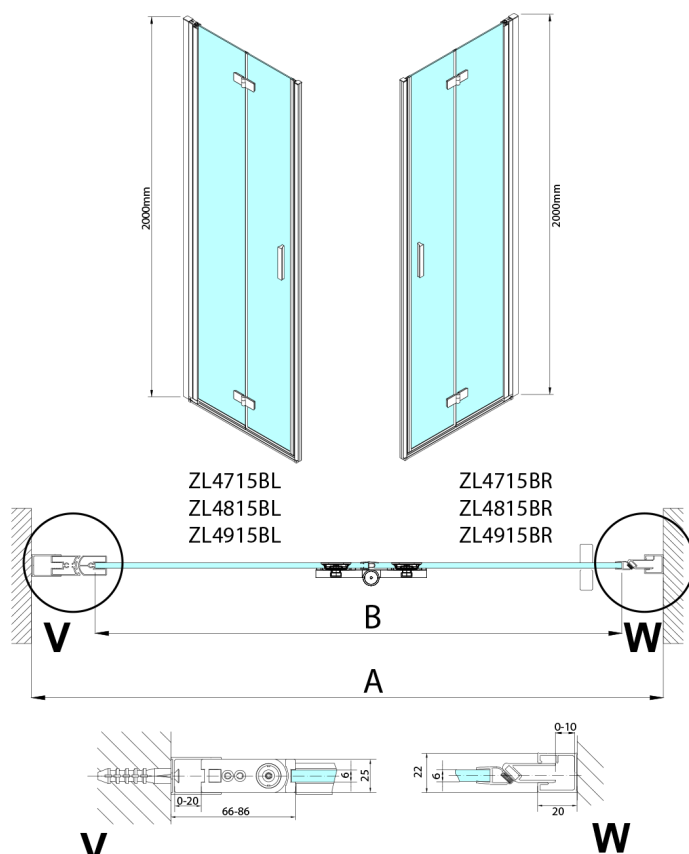

Model	A	B
ZL4715B	685-715	697
ZL4815B	785-815	797
ZL4915B	885-915	897

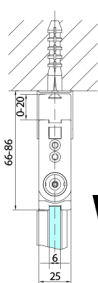
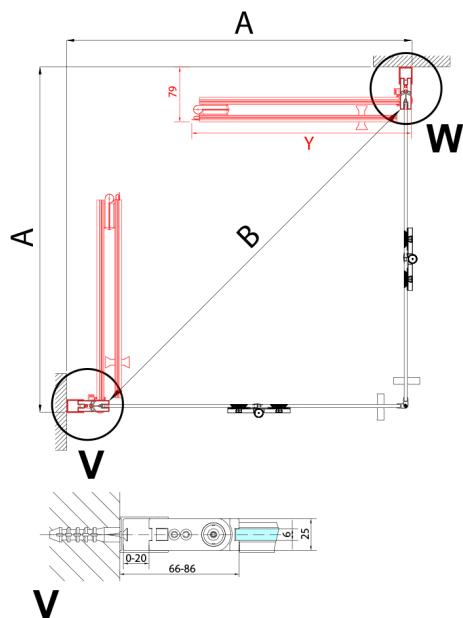

Model	A	B	Y
ZL4715B	670-690	837	339
ZL4815B	770-790	978	378
ZL4915B	870-890	1119	438

W

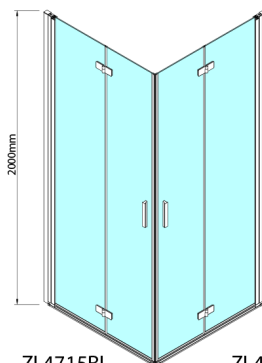

ZL4715BL  
ZL4815BL  
ZL4915BL

ZL4715BR  
ZL4815BR  
ZL4915BR

Model L		Model R	A	B	C	Y	Z
ZL4715BL	+	ZL4815BR	670-690	770-790	907	378	339
ZL4715BL	+	ZL4915BR	670-690	870-890	978	438	339
ZL4815BL	+	ZL4915BR	770-790	870-890	1048	438	378
ZL4815BL	+	ZL4715BR	770-790	670-690	907	339	378
ZL4915BL	+	ZL4715BR	870-890	670-690	978	339	438
ZL4915BL	+	ZL4815BR	870-890	770-790	1048	378	438

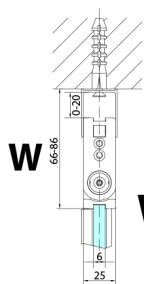
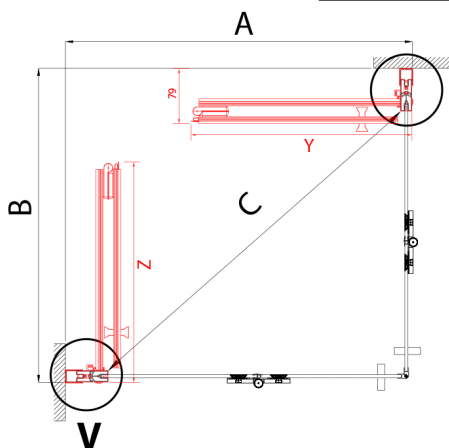

W

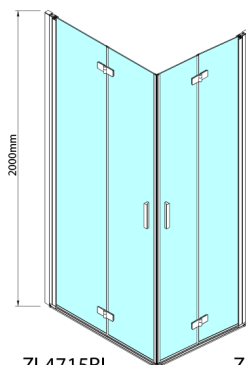

ZL4715BL  
ZL4815BL  
ZL4915BL

ZL4715BR  
ZL4815BR  
ZL4915BR

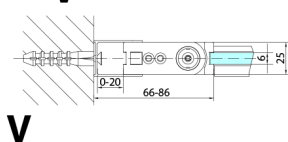

V