

Bestellcode: ES1211

**Größe**

Breite: 1067 mm

Höhe: 2100 mm

**Eigenschaften**

Garantie: 3 Jahre



**Technisches Arbeitsblatt**

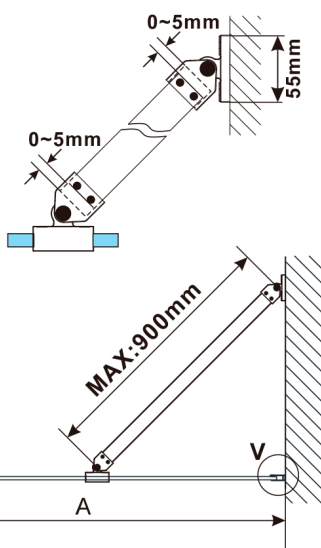
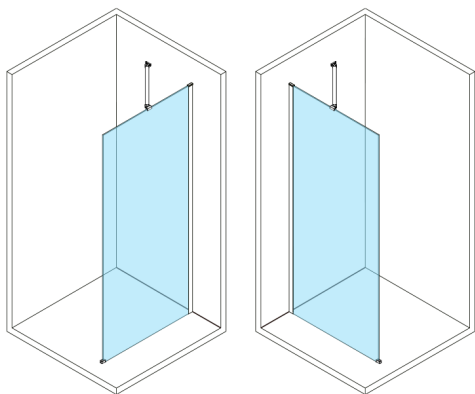

MODEL	A,mm
ES1070,ES1170,ES1270,ES1370,ES1570	690-705
ES1080,ES1180,ES1280,ES1380,ES1580	790-805
ES1090,ES1190,ES1290,ES1390,ES1590	890-905
ES1010,ES1110,ES1210,ES1310,ES1510	990-1005
ES1011,ES1111,ES1211,ES1311,ES1511	1090-1105
ES1012,ES1112,ES1212,ES1312,ES1512	1190-1205
ES1013,ES1113,ES1213,ES1313,ES1513	1290-1305
ES1014,ES1114,ES1214,ES1314,ES1514	1390-1405
ES1015,ES1115,ES1215,ES1315,ES1515	1490-1505

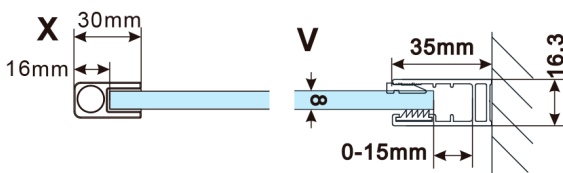

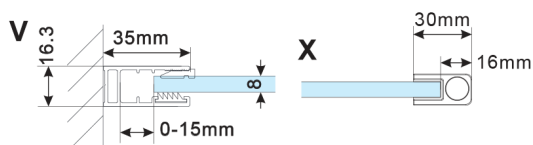
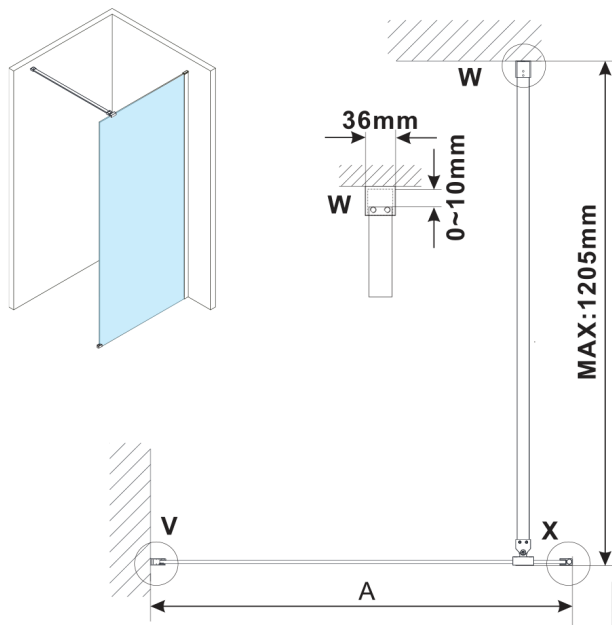

MODEL	A,mm
ES1070, ES1170, ES1270, ES1370, ES1570	690~705
ES1080, ES1180, ES1280, ES1380, ES1580	790~805
ES1090, ES1190, ES1290, ES1390, ES1590	890~905
ES1010, ES1110, ES1210, ES1310, ES1510	990~1005
ES1011, ES1111, ES1211, ES1311, ES1511	1090~1105
ES1012, ES1112, ES1212, ES1312, ES1512	1190~1205
ES1013, ES1113, ES1213, ES1313, ES1513	1290~1305
ES1014, ES1114, ES1214, ES1314, ES1514	1390~1405
ES1015, ES1115, ES1215, ES1315, ES1515	1490~1505



MODEL	A,mm
ES1070,ES1170,ES1270,ES1370,ES1570	699
ES1080,ES1180,ES1280,ES1380,ES1580	799
ES1090,ES1190,ES1290,ES1390,ES1590	899
ES1010,ES1110,ES1210,ES1310,ES1510	999
ES1011,ES1111,ES1211,ES1311,ES1511	1099
ES1012,ES1112,ES1212,ES1312,ES1512	1199
ES1013,ES1113,ES1213,ES1313,ES1513	1299
ES1014,ES1114,ES1214,ES1314,ES1514	1399
ES1015,ES1115,ES1215,ES1315,ES1515	1499

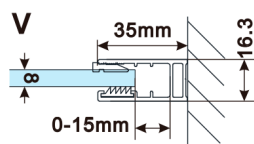
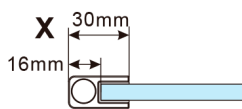
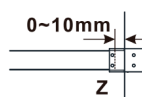
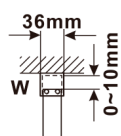
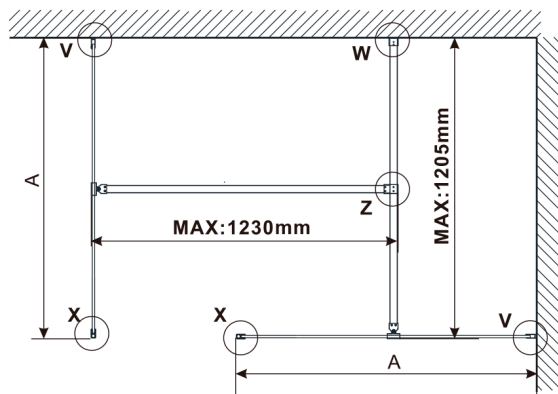
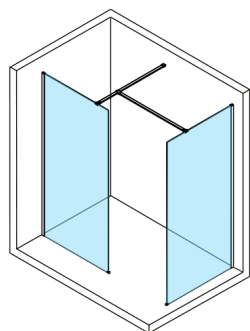
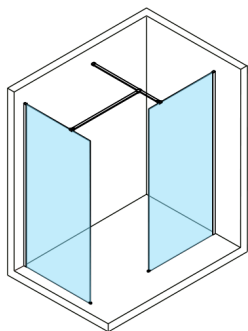

MODEL	A,mm
ES1070, ES1170, ES1270, ES1370, ES1570	690-705
ES1080, ES1180, ES1280, ES1380, ES1580	790-805
ES1090, ES1190, ES1290, ES1390, ES1590	890-905
ES1010, ES1110, ES1210, ES1310, ES1510	990-1005
ES1011, ES1111, ES1211, ES1311, ES1511	1090-1105
ES1012, ES1112, ES1212, ES1312, ES1512	1190-1205
ES1013, ES1113, ES1213, ES1313, ES1513	1290-1305
ES1014, ES1114, ES1214, ES1314, ES1514	1390-1405
ES1015, ES1115, ES1215, ES1315, ES1515	1490-1505