

## ROLLS Rechteckige Duschkabine 1500x800 mm, L/R Variante, Klarglas

**Bestellcode:** RL1515RL3215

**Größe**

Breite: 1500 mm  
 Höhe: 2000 mm  
 Tiefe: 800 mm

**Eigenschaften**

Garantie: 2 Jahre



### Technisches Arbeitsblatt

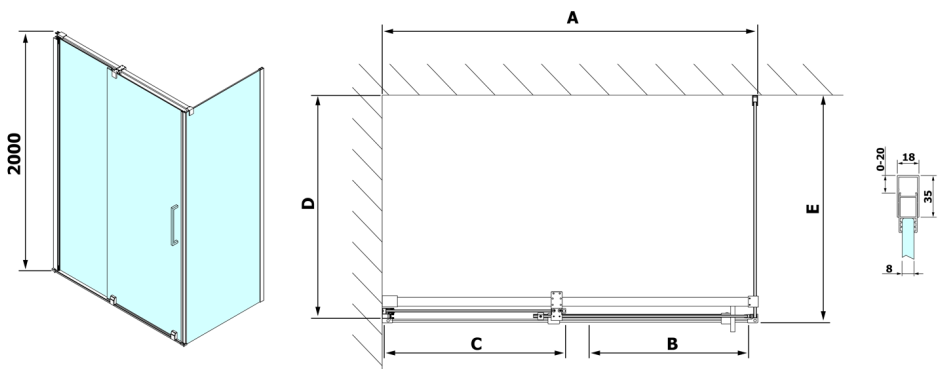

Model	D	E
RL3215	765-785	780-800
RL3315	865-885	880-900
RL3415	965-985	980-1000

Model	A	B	C
RL1115	1070-1110	425	~500
RL1215	1170-1210	475	~550
RL1315	1270-1310	525	~600
RL1415	1370-1410	575	~650
RL1515	1470-1510	625	~700
RL1615	1570-1610	675	~750

