

# FORTIS Rechteckige Duschkabine 1500x1200 mm, L Variante



**Bestellcode:** FL1115LFL3512

## Grundinformation

**Marke:** Polysan

**Serie:** FORTIS

## Größe

**Breite:** 1500 mm

**Höhe:** 2000 mm

**Tiefe:** 1200 mm

## Eigenschaften

**Farbenprofil:** Chrom - Poliertem Aluminium

**Form:** Rechteckige Duschtrennungen

**Öffnungsarten:** Öffnungstür einflügelig

**Richtung der Öffnung:** Links

**Eingangsbreite:** 565 mm

**Glasfarbe:** Klarglas

**Glasbehandlung:** Antidrop

**Glasdicke:** 8 mm

**Eigenschaften:** Rahmenloses Design

**Gewicht / Stück:** 109.0 kg

**Verpackung:** 2 Stück

**Garantie:** 2 Jahre



Technisches Arbeitsblatt



FL10xxL  
FL11xxL

FL3580  
FL3590  
FL3510  
FL3511  
FL3512



FL3580  
FL3590  
FL3510  
FL3511  
FL3512

FL10xxR  
FL11xxR

**FORTIS** Rechteckige Duschkabine 1500x1200 mm, L  
Variante



Dveře	A (mm)	B (mm)	C (mm)
FL1080	785-801	≈ 200	779-795
FL1090	885-901	≈ 300	879-895
FL1010	985-1001	≈ 400	979-995
FL1011	1085-1101	≈ 500	1079-1095
FL1012	1185-1201	≈ 600	1179-1195
FL1113	1285-1301	≈ 700	1279-1295
FL1114	1385-1401	≈ 800	1379-1395
FL1115	1485-1501	≈ 900	1479-1495

Boční stěna	E	D
FL3580	785-801	779-795
FL3590	885-901	879-895
FL3510	985-1001	979-995
FL3511	1085-1101	1079-1095
FL3512	1185-1201	1179-1195



**FORTIS** Rechteckige Duschkabine 1500x1200 mm, L  
Variante



Stavební připravenost pro montáž na dlažbu  
kóty  $x, y$  = Rozměr k vnitřní straně skla

Construction readiness for floor mounting  
dimensions  $x, y$  = Dimension to the inside of the glass

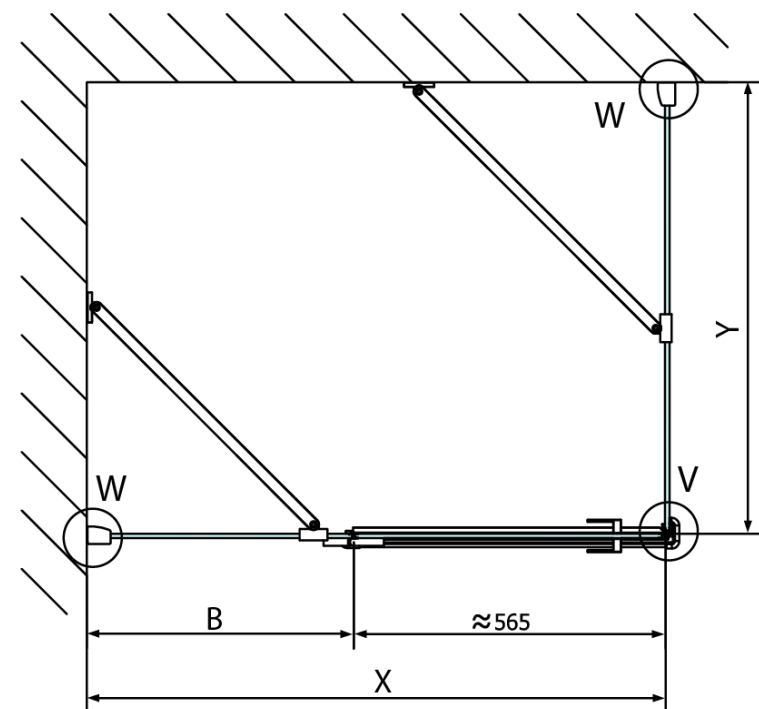

Dveře	X (mm)	B (mm)
FL1080	768	≈ 200
FL1090	868	≈ 300
FL1010	968	≈ 400
FL1011	1068	≈ 500
FL1012	1168	≈ 600
FL1113	1268	≈ 700
FL1114	1368	≈ 800
FL1115	1468	≈ 900

Boční stěna	Y
FL3580	768
FL3590	868
FL3510	968
FL3511	1068
FL3512	1168

