

# FORTIS Rechteckige Duschkabine 1500x1100 mm, R Variante



**Bestellcode:** FL1115RFL3511

## Grundinformation

**Marke:** Polysan  
**Serie:** FORTIS

## Größe

**Breite:** 1500 mm  
**Höhe:** 2000 mm  
**Tiefe:** 1100 mm

## Eigenschaften

**Farbenprofil:** Chrom - Poliertem Aluminium  
**Form:** Rechteckige Duschtrennungen  
**Öffnungsarten:** Öffnungstür einflügelig  
**Richtung der Öffnung:** Rechts  
**Eingangsbreite:** 565 mm  
**Glasfarbe:** Klarglas  
**Glasbehandlung:** Antidrop  
**Glasdicke:** 8 mm  
**Eigenschaften:** Rahmenloses Design  
**Gewicht / Stück:** 105.0 kg  
**Verpackung:** 2 Stück  
**Garantie:** 2 Jahre



Technisches Arbeitsblatt



FL10xxL  
FL11xxL

FL3580  
FL3590  
FL3510  
FL3511  
FL3512



FL3580  
FL3590  
FL3510  
FL3511  
FL3512

FL10xxR  
FL11xxR

**FORTIS** Rechteckige Duschkabine 1500x1100 mm, R  
Variante

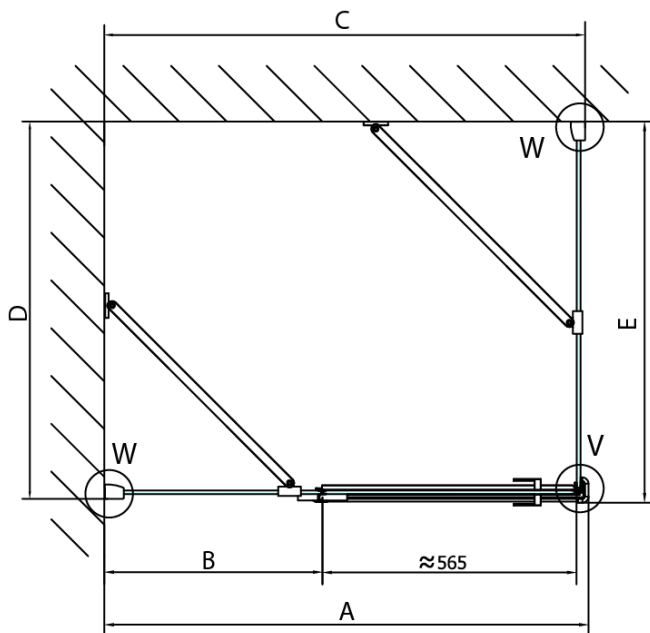

Dveře	A (mm)	B (mm)	C (mm)
FL1080	785-801	≈ 200	779-795
FL1090	885-901	≈ 300	879-895
FL1010	985-1001	≈ 400	979-995
FL1011	1085-1101	≈ 500	1079-1095
FL1012	1185-1201	≈ 600	1179-1195
FL1113	1285-1301	≈ 700	1279-1295
FL1114	1385-1401	≈ 800	1379-1395
FL1115	1485-1501	≈ 900	1479-1495

Boční stěna	E	D
FL3580	785-801	779-795
FL3590	885-901	879-895
FL3510	985-1001	979-995
FL3511	1085-1101	1079-1095
FL3512	1185-1201	1179-1195



**FORTIS Rechteckige Duschkabine 1500x1100 mm, R**  
**Variante**



Stavební připravenost pro montáž na dlažbu  
 kóty  $x, y$  = Rozměr k vnitřní straně skla

Construction readiness for floor mounting  
 dimensions  $x, y$  = Dimension to the inside of the glass

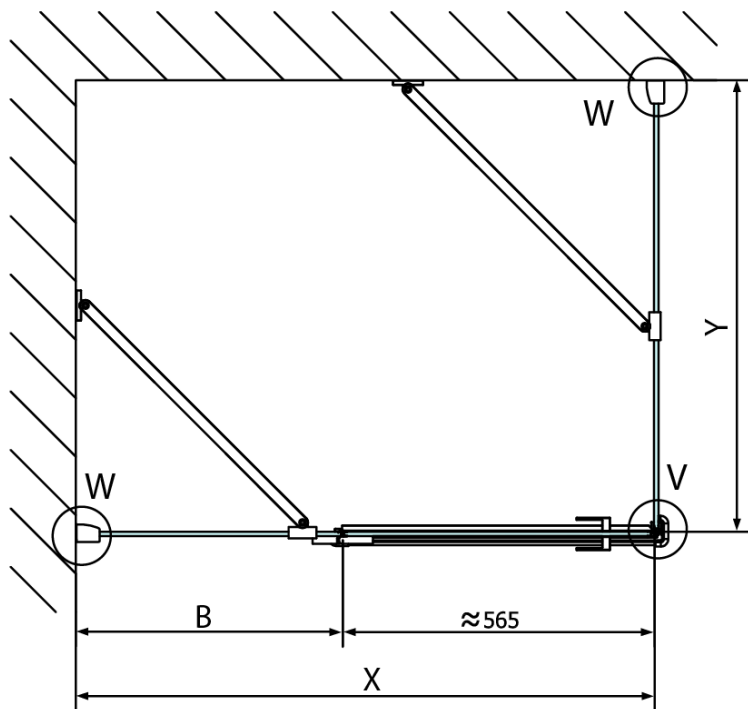

Dveře	X (mm)	B (mm)
FL1080	768	$\approx 200$
FL1090	868	$\approx 300$
FL1010	968	$\approx 400$
FL1011	1068	$\approx 500$
FL1012	1168	$\approx 600$
FL1113	1268	$\approx 700$
FL1114	1368	$\approx 800$
FL1115	1468	$\approx 900$

Boční stěna	Y
FL3580	768
FL3590	868
FL3510	968
FL3511	1068
FL3512	1168

