

ALTIS Schiebetür 1470-1510mm, Höhe 2000mm, Klarglas



Bestellcode: AL4215C

Grundinformation

Marke: Polysan

Serie: ALTIS

Größe

Breite: 1500 mm

Höhe: 2000 mm

Eigenschaften

Farbenprofil: Chrom - Poliertem Aluminium

Form: Nischetür

Öffnungsarten: Schiebetür

Richtung der Öffnung: Universelle

Eingangsbreite: 625 mm

Glasfarbe: Klarglas

Glasbehandlung: Antidrop

Glasdicke: 8 mm

Einbaubreite ab: 1470 mm

Einbaubreite bis zu: 1510 mm

Eigenschaften: Rahmenloses Design

Gewicht / Stück: 35.0 kg

Verpackung: 1 Stück

Garantie: 2 Jahre



Ersatzteile

ALTIS Installationsset (Bestellcode: NDAL01)

DRAGON, FONDURA, ALTIS Untere Dichtung, 1000 mm (Bestellcode: NDGD02)

FONDURA Dichtung für Tür (Bestellcode: NDAL02)

ALTIS/ROLLS/DRAGON Satz Schraubenabdeckungen (Bestellcode: NDAL03)

ALTIS Satz vertikaler Dichtungen (Bestellcode: NDAL06)

ALTIS Rollen (Bestellcode: NDAL04)

ALTIS Haltegriff (Bestellcode: NDAL-MADLO)

Technisches Arbeitsblatt

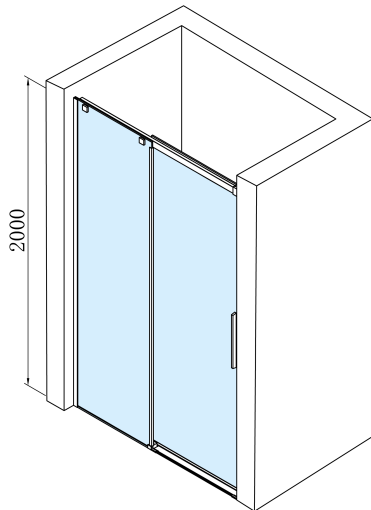

MODEL	A	B	C
AL3915C	1070-1110	498	425
AL3015C	1170-1210	548	475
AL4015C	1270-1310	598	525
AL4115C	1370-1410	648	575
AL4215C	1470-1510	698	625
AL4315C	1570-1610	748	675

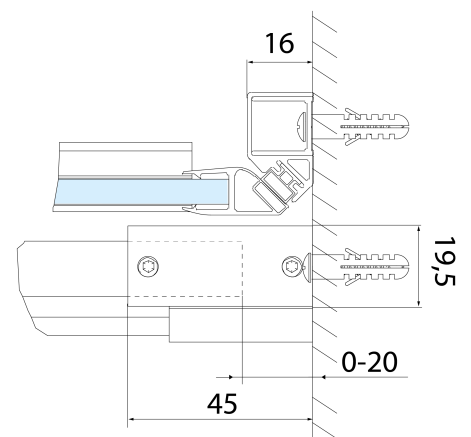
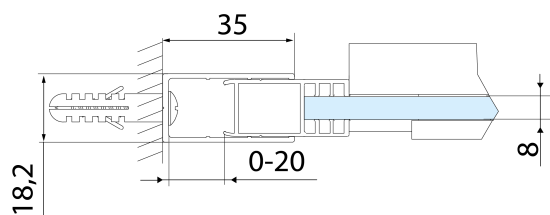
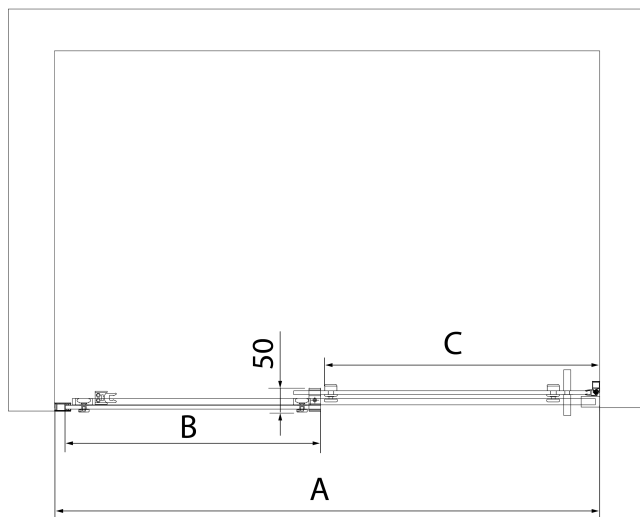

**ALTIS Schiebetür 1470-1510mm, Höhe 2000mm,
Klarglas**

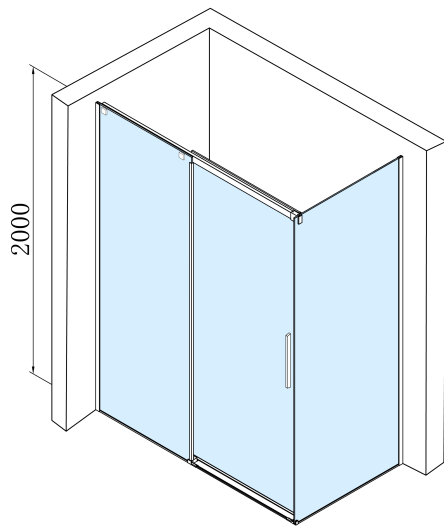

MODEL	A	B	C
AL3915C	1082-1122	498	425
AL3015C	1182-1222	548	475
AL4015C	1282-1322	598	525
AL4115C	1382-1422	648	575
AL4215C	1482-1522	698	625
AL4315C	1582-1622	748	675

MODEL	D
AL5915C	780-800
AL6015C	880-900
AL6115C	980-1000

