

**ARCHITEX temperiert graues Glas, L 1200 - 1600mm,
H 1800-2600mm**



Bestellcode: ALS1216

Grundinformation

Marke: Polysan
Serie: ARCHITEX

Eigenschaften

Glasfarbe: Grauesglas
Glasbehandlung: Antidrop
Glasdicke: 8 mm
Gewicht / Stück: 87.0 kg
Verpackung: 1 Stück
Garantie: 2 Jahre



Technisches Arbeitsblatt

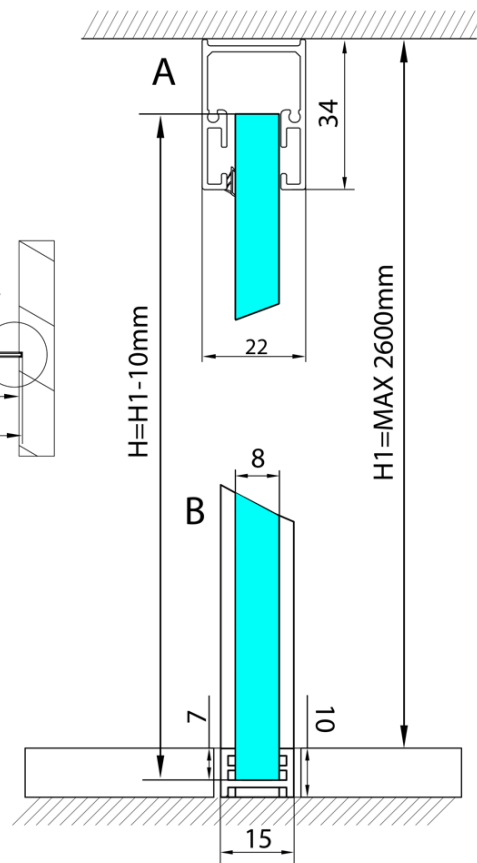
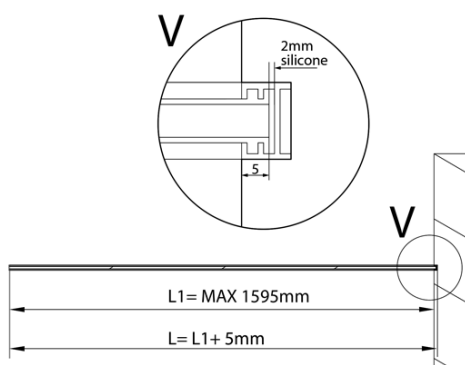

L1=MAX 1595	H1=MAX 2600
L=L1+5=1600	H=H1-10=2590