

# FORTIS Rechteckige Duschkabine 1400x800 mm, L Variante



**Bestellcode:** FL1114LFL3580

## Grundinformation

**Marke:** Polysan  
**Serie:** FORTIS

## Größe

**Breite:** 1400 mm  
**Höhe:** 2000 mm  
**Tiefe:** 800 mm

## Eigenschaften

**Farbenprofil:** Chrom - Poliertem Aluminium  
**Form:** Rechteckige Duschtrennungen  
**Öffnungsarten:** Öffnungstür einflügelig  
**Richtung der Öffnung:** Links  
**Eingangsbreite:** 565 mm  
**Glasfarbe:** Klarglas  
**Glasbehandlung:** Antidrop  
**Glasdicke:** 8 mm  
**Eigenschaften:** Rahmenloses Design  
**Gewicht / Stück:** 90.0 kg  
**Verpackung:** 2 Stück  
**Garantie:** 2 Jahre



Technisches Arbeitsblatt



**FORTIS Rechteckige Duschkabine 1400x800 mm, L  
Variante**



Dveře	A (mm)	B (mm)	C (mm)
FL1080	785-801	≈ 200	779-795
FL1090	885-901	≈ 300	879-895
FL1010	985-1001	≈ 400	979-995
FL1011	1085-1101	≈ 500	1079-1095
FL1012	1185-1201	≈ 600	1179-1195
FL1113	1285-1301	≈ 700	1279-1295
FL1114	1385-1401	≈ 800	1379-1395
FL1115	1485-1501	≈ 900	1479-1495

Boční stěna	E	D
FL3580	785-801	779-795
FL3590	885-901	879-895
FL3510	985-1001	979-995



**FORTIS Rechteckige Duschkabine 1400x800 mm, L**  
**Variante**



Stavební připravenost pro montáž na dlažbu  
 kóty  $x, y$  = Rozměr k vnitřní straně skla

Construction readiness for floor mounting  
 dimensions  $x, y$  = Dimension to the inside of the glass

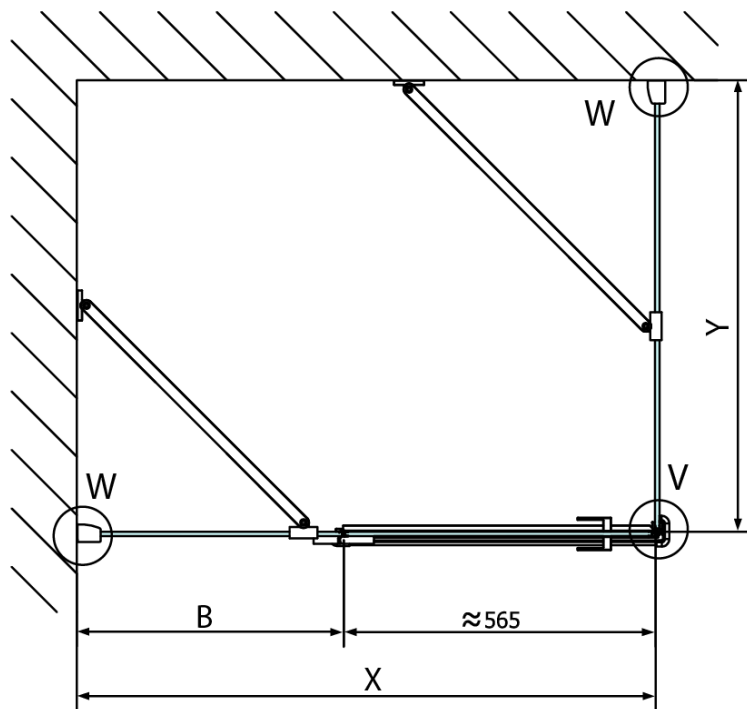

Dveře	X (mm)	B (mm)
FL1080	768	≈ 200
FL1090	868	≈ 300
FL1010	968	≈ 400
FL1011	1068	≈ 500
FL1012	1168	≈ 600
FL1113	1268	≈ 700
FL1114	1368	≈ 800
FL1115	1468	≈ 900

Boční stěna	Y
FL3580	768
FL3590	868
FL3510	968
FL3511	1068
FL3512	1168

